



**Microprocessor Controlled
I G B T Drive
Inverter Motor Speed Regulator
Operating Manual**

S310 Serise 200V class

0.4~1.5KW
(0.88~2.9KVA)



Chapter 0	Preface	0-1
0.1	Preface	0-1
0.2	Product Inspection	0-1
Chapter 1	Safety Precautions	1-1
1.1	Operation Precautions	1-1
	1.1.1 Before Power UP	1-1
	1.1.2 During Power UP	1-2
	1.1.3 Before Operation	1-2
	1.1.4 During Operation	1-2
	1.1.5 During Maintenance	1-3
Chapter 2	Definition of Model	2-1
Chapter 3	Ambient Environment and Installation	3-1
3.1	Environment	3-1
3.2	Environmental Precautions	3-2
3.3	Electrical Installation	3-3
	3.3.1 Wiring guidelines	3-3
	3.3.2 Contactor and Circuit Breaker specification and wiring	3-4
	3.3.3 Precautions for Peripheral Applications	3-5
3.4	Specifications	3-8
	3.4.1 Product Specifications	3-8
	3.4.2 General Specifications	3-8
3.5	Wiring Diagram S310 Series Inverter	3-10
3.6	Description of connection terminals	3-11
3.7	Outline Dimension	3-13
Chapter 4	Software Index	4-1
4.1	Keypad Description	4-1
4.2	S310 Programmable Functions List	4-3
4.3	Parameter Function Description	4-11
Chapter 5	Troubleshooting and Maintenance	5-1
5.1	Error Display and Corrective Action	5-1
	5.1.1 Error Display and Corrective Action	5-1
	5.1.2 Special conditions	5-2
	5.1.3 Operation errors	5-3
	5.1.4 The instructions for the Power and Alarm LED of the inverter	5-3
5.2	General Troubleshooting	5-4
5.3	Quick troubleshooting of S310 series	5-5
5.4	Routine and periodic inspection	5-11
5.5	Maintenance and Inspection	5-12
Chapter 6	Peripheral Components	6-1
6.1	AC reactor and DC reactor specification at input side	6-1
6.2	Digital operator and extension cable	6-1
Appendix I	S310 Parameters Setting List	App1

Index of Figures

Figure 2-1 Inverter Nameplate.....	2-1
Figure 3-1 Panel and enclosure arrangement for S310 inverters	3-1
Figure 3-2 Din rail mounting of the S310 inverter.....	3-1
Figure 3-3 Typical Installation Schematic.....	3-5
Figure 3-4a) Installation Examples.....	3-6
b) Installation Examples Using a Filter and Isolation transformer	3-6
c) Installation Examples with Adjacent Signal Conductors	3-6
Figure 3-5 Control Cable requirements.....	3-7
Figure 3-6 Grounding Examples	3-7
Figure 3-7 Wiring Diagram.....	3-10
Figure 3-8 Power Input Locations	3-12
Figure 3-9 Frame size 1 Dimensions	3-13
Figure 3-10 Frame size 2 Dimensions	3-14
Figure 3-11 Frame size 3 Dimensions	3-15
Figure 3-12 Frame size 4 Dimensions	3-16
Figure 3-13 Frame size 5 Dimensions	3-17
Figure 3-14 Frame size 6 Dimensions	3-18
Figure 4-1 Keypad Layout	4-1
Figure 4-2 LED Keypad Operations Sequence.....	4-2
Figure 4-3 Frequency reference limits	4-11
Figure 4-4 Terminal Board Drive Operation Modes	4-12
Figure 4-5 3-Wires Start/Stop Wiring.....	4-12
Figure 4-6 Drive Start/Stop Operation sequences	4-12
Figure 4-7 Frequency within specified range example.....	4-15
Figure 4-8 Frequency outside of range example.....	4-15
Figure 4-9 Frequency at or below specified range example	4-15
Figure 4-10 Analog scaling examples	4-16
Figure 4-11 DC Injection Braking Example.....	4-20
Figure 4-12 Custom V/F settings	4-21
Figure 4-13 V/F curve with torque boost.....	4-22
Figure 4-14 Single cycle auto run	4-27
Figure 4-15 Periodic cycle auto run.....	4-27
Figure 4-16 Single cycle auto run: final step hold.....	4-28
Figure 4-17 AUTO_RUN cycle with interrupt.....	4-28
Figure 5-1 S310 Fault Display and Troubleshooting Flow Chart	5-6
Figure 5-2 OC, OL Fault Display Flow Chart.....	5-7
Figure 5-3 OV, LV Fault Display Flow Chart.....	5-8
Figure 5-4 Motor RUN failure Flow chart	5-9
Figure 5-5 Motor Overheat Troubleshooting Flow Chart	5-10
Figure 5-6 Motor Instability Troubleshooting Flow Chart	5-10
Figure 6-1 Digital Operator Extension Cable.....	6-1

Chapter 0 Preface

0.1 Preface

To extend the performance of the product and ensure personnel safety, please read this manual thoroughly before using the inverter. Should there be any problem in using the product that can not be solved with the information provided in the manual, contact your nearest TECO's technical or sales representative who will be willing to help you.

※Precautions

The inverter is an electrical product. For your safety, there are symbols such as “Danger”, “Caution” in this manual as a reminder to pay attention to safety instructions on handling, installing, operating, and checking the inverter. Be sure to follow the instructions for highest safety.

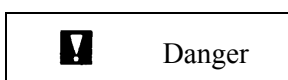

Indicates a potential hazard that could cause death or serious personal injury if misused.

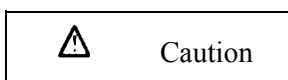

Indicates that the inverter or the mechanical system might be damaged if misused.

Danger

- Do not touch any circuit boards or components after the power is turned off and while the charging indicator is still lit. (The light will fade)
- Do not make any connections when the inverter is powered on. Do not check parts and signals on circuit boards during the inverter operation.
- Do not disassemble the inverter or modify any internal wires, circuits, or parts.
- Ground the ground terminal of the inverter properly.

For 200V class ground resistance 100 Ω or below. For 400V class 10 Ω or below.

Caution

- Do not perform a voltage test on parts inside the inverter. High voltage can destroy the semiconductor components.
- Do not connect U, V, and W terminals of the inverter to any AC input power supply.
- CMOS ICs on the inverter's main board are susceptible to static electricity. Do not touch the main circuit board

0.2 Product Inspection

TECO inverters have all passed the function test before delivery. Please check the following when you receive and unpack the inverter:

- The model of the inverter are the same as those specified in your purchase order.
- Check for any damages caused by transportation. Please do not apply power, and contact a TECO sales representative if any of the above problems occurred.

Chapter 1 Safety Precautions

1.1 Operation Precautions

1.1.1. Before Power Up

⚠ Caution

The line voltage applied must comply with the inverter's specified input voltage.(See product nameplate)

⚡ Danger

Make sure the main circuit connections are correct. L1, L2 and are power-input terminals and must not be mistaken for U, V and W. Otherwise, inverter damage can result.

⚠ Caution

- To avoid the front cover from disengaging or other damage, do not carry the inverter by its cover. Support the drive by its heat sink when transporting. Improper handling can damage the inverter or injure personnel, and should be avoided.
- To avoid the risk of fire, do not install the inverter on flammable objects. Install on nonflammable objects such as metal surfaces.
- If several inverters are placed in the same control panel, provide heat extraction means to keep the temperature below 40°C to avoid overheat or fire hazard.
- When removing or installing the operator keypad, turn OFF the power first, and secure the keypad correctly to avoid keypad operation or display failure.

Warning

This product is sold subject to IEC 61800-3. In a domestic environment this product may cause radio interference in which case the user may be required to apply corrective measures.

1.1.2. During Power Up

Danger

- When the momentary power loss is short, the inverter still has enough storage power to control the circuit. Therefore, when power is re-applied, the inverter will automatically restart depending on the setup of 04-03.
- When **restarting** the inverter, the operation of the inverter is based on the setup of 00-03 and 04-09 and the condition of external switch (FWD/REV button). Attention: the start operation will be regardless of 04-03.
 1. When 00-03 =0, the inverter will not automatically run after restart.
 2. When 00-03 =1 and the external switch (FWD/REV button) is OFF, the inverter will not run after restart.
 3. When 00-03 =1, the external switch (FWD/REV button) is ON, and 04-09=0, the inverter will run automatically after restart.

Attention: To ensure safety, please turn off the external switch (FWD/REV button) after power loss, to protect machines from possible damage and potential injury to personnel on sudden resumption of power.
- If 4-09 is set to 0 (direct start up), please refer to the description and warnings for 04-09 to verify the safety of operator and machine.

1.1.3. Before Operation

Danger

Make sure the model and inverter capacity are the same as that set in parameter 12-00.

Caution

On power up the supply voltage set in parameter 05-03 will flash on display for 2 seconds.

1.1.4. During Operation

Danger

Do not connect or disconnect the motor during operation. Otherwise, the over-current will cause the inverter to trip or damage the unit.

⚠ Danger

- To avoid electric shock, do not take the front cover off when power is on.
 - The motor will restart automatically after stop when auto-restart function is on. In this case, use caution while working near the drive, motor, or driven equipment.
 - Note: The stop push button and external stop command have no safety function.
- For Emergency stop, it is necessary to use a correct latch type push button and an appropriate circuit or devices to ensure safety.

⚠ Caution

- Do not touch heat-generating components such as heat sinks and braking resistors.
- The inverter can drive the motor from low speed to high speed. Verify the allowable speed range of the motor and the load before operation.
- Note the settings related to the braking unit.
- Do not check signals on circuit boards while the inverter is running.

⚠ Caution

Allow 5 minutes after disconnecting power before disassembling or checking the components. The power led should not be illuminated.

1.1.5. During Maintenance**⚠ Caution**

The Inverter can be used in environment in temperature range from 14°-104°F (-10-40°C) and relative humidity of 95%.

Inverter Disposal**⚠ Caution**

- Please dispose of this unit with care as an industrial waste and according to your required local regulations.
- The capacitors of inverter main circuit and printed circuit board are considered as hazardous waste and must not be burnt.
- The Plastic enclosure and parts of the inverter such as the top cover board will release harmful gases if burnt.

Chapter 2 Definition of model

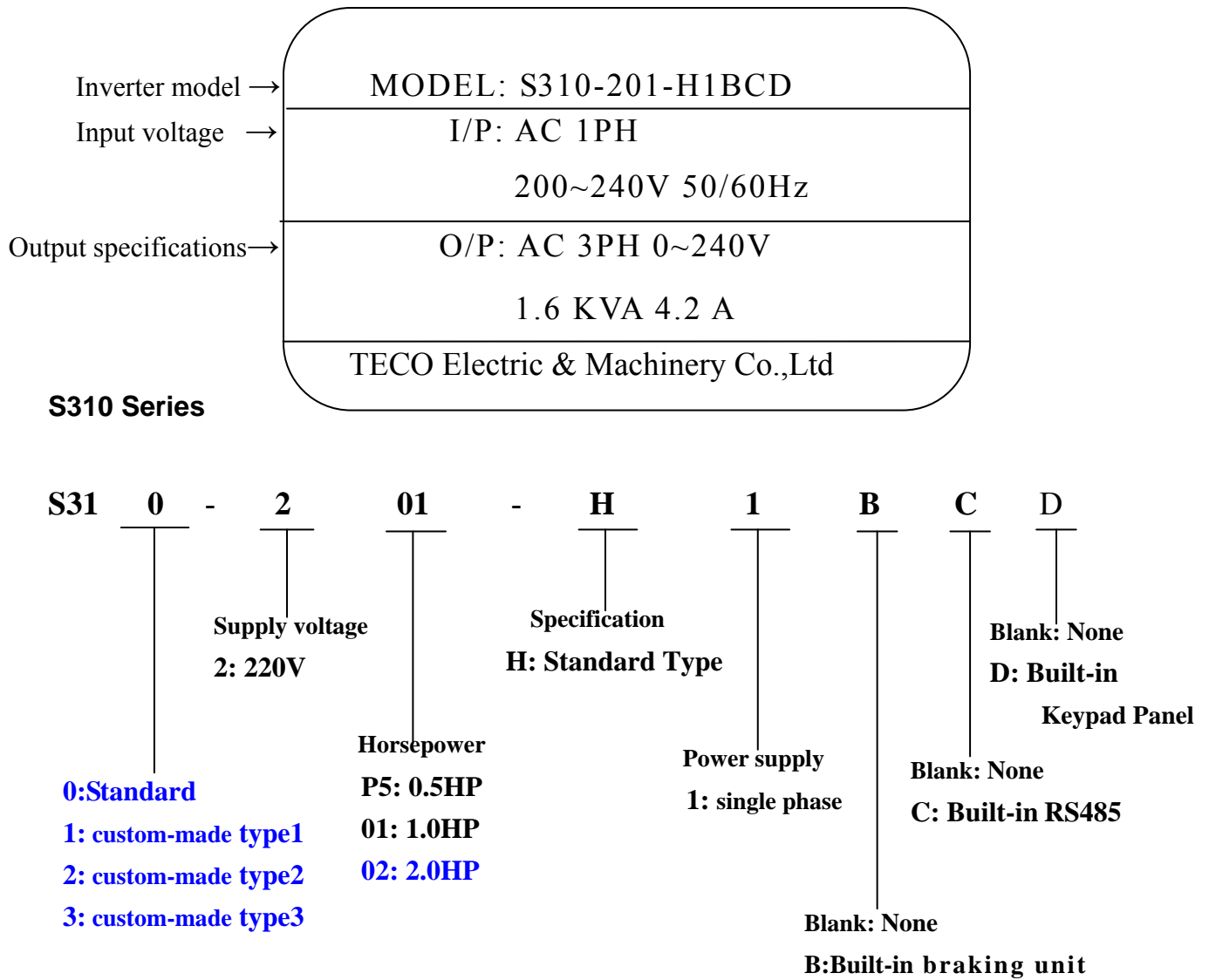

Figure 2-1 Inverter Nameplate

Chapter 3 Ambient Environment and Installation

3.1 Environment

The environment will directly affect the proper operation and the life span of the inverter, so install the inverter in an environment complying with the following conditions:

- Ambient temperature: 14-104°F(-10oC - +40oC)
(S310-202Model Ambient temperature : Carrier Frequency >5KHz, Tc≤35°C)
- Avoid exposure to rain or moisture.
- Avoid oil mist and salinity.
- Avoid dust, lint fibers, and small metal filings.
- Avoid electromagnetic interference (soldering machine, power machine).
- Avoid vibration (stamping, punching machine). Add a vibration-proof pad if the situation cannot be avoided.
- If several inverters are placed in the same control panel, provide heat removal means to maintain temperatures below 40°C.
- Avoid direct sunlight.
- Avoid corrosive liquid and gas.
- Keep away from radioactive and flammable materials.

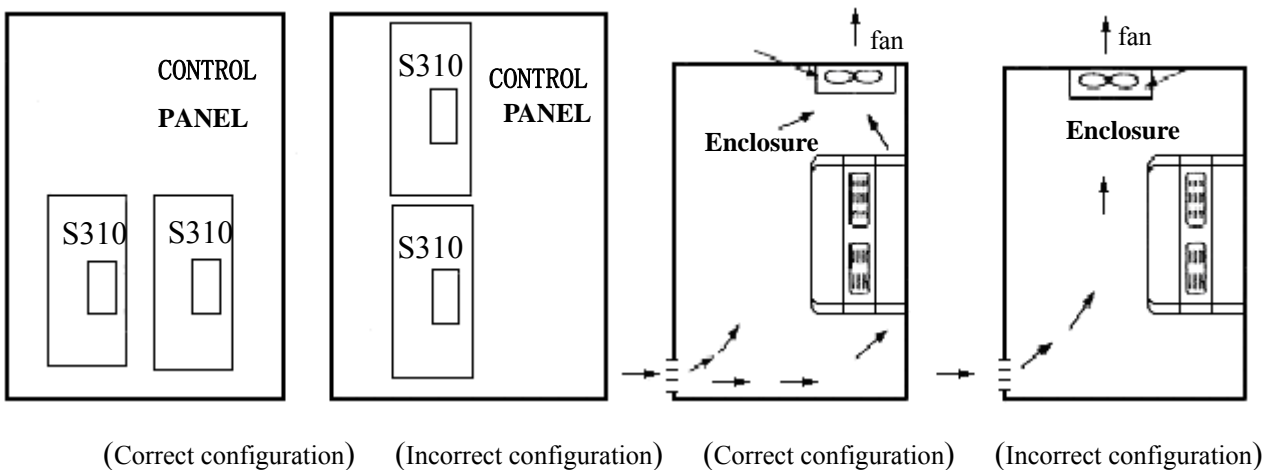

Figure 3-1 Panel and enclosure arrangement for S310 inverters

- Place the inverter facing forward and its top facing upward to assist with cooling.

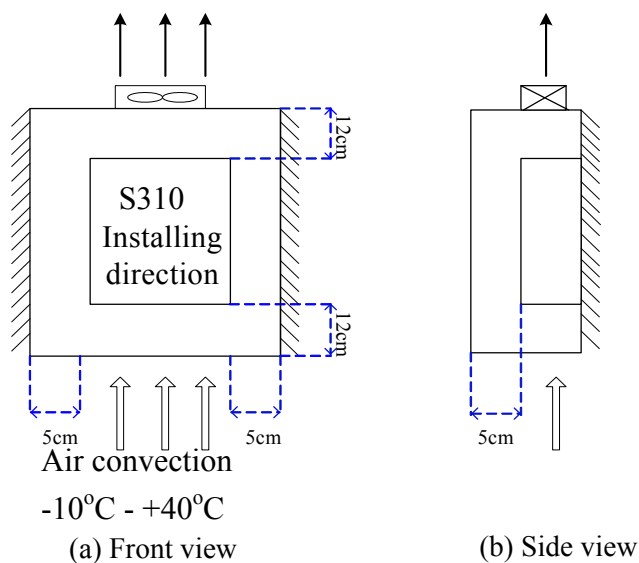
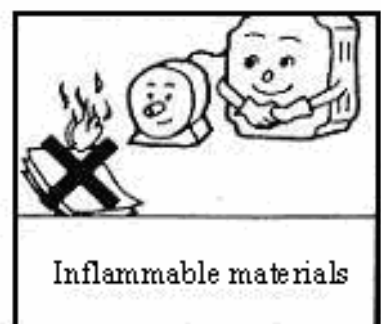
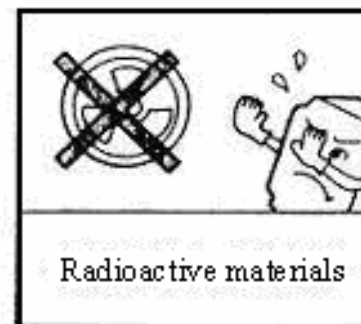
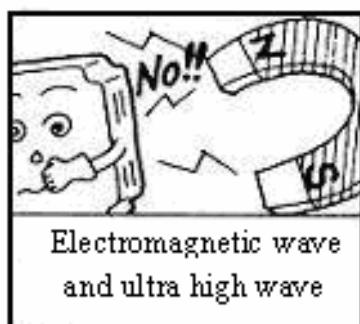
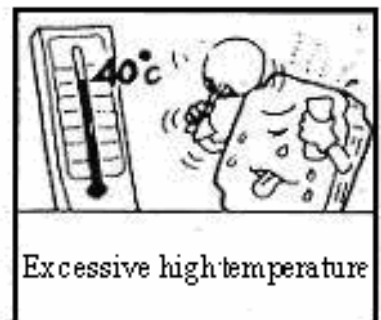
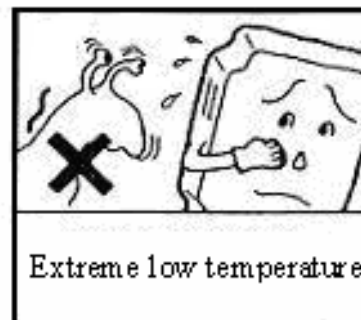
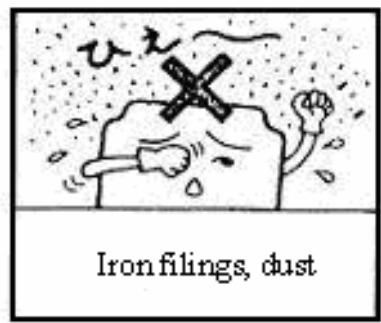
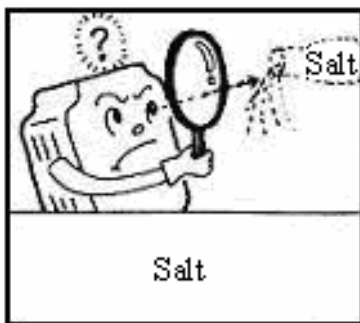
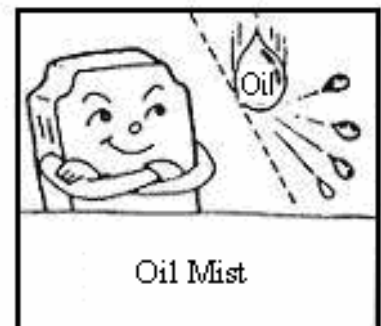
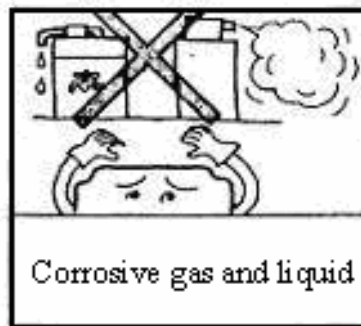
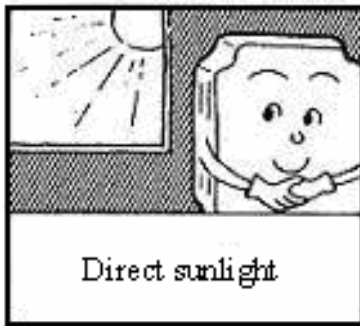

Figure 3-2 Din rail mounting of the S310 Inverter

3.2 Environmental precautions

Do not use the inverter in an environment with the following conditions:



3.3 Electrical Installation

3.3.1 Wiring guidelines

A. Tightening torque:

Required Screwdriver Torques are as listed below:

Tightening torque			
Horsepower	Power source	Nominal torque for TM1 terminal	
0.5/1/2	200-240V	0.59/0.08 (LBS-FT / KG-M)	7.10/8.20 (LBS-IN/KG-CM)

B. Power Cables

Power cables are connected to TM1 terminal block, terminals L1, L2, U, V, W, P1, BR.

Choose power cables according to the following criteria:

- (1) Use copper wires only. Correct wire diameters should be based on ratings at 105°C.
- (2) For rating voltage of wires, the minimum voltage of 240V class type is 300V.

C. Control Cables

Control cables are connected to TM2 control terminal block.

Choose control cables according to the following criteria:

- (1) Use copper wires only. Correct wire diameters should be based on ratings at 105°C.
- (2) For rating voltage of wires, the minimum voltage of 200V class type is 300V. To avoid noise interference, do not route power and control cables in the same conduit or trucking.
- (3) Where possible use screened / shielded control cables to minimize electromagnetic interference. To avoid ground loops always earth the shield of control cables at one end only.

D. Nominal electrical specifications of the terminal Block TM1:

Horsepower	Power source	Amps	Volts
0.5/1/2	200-240V	15	600

※Note: Nominal values of input and output signals (TM2) – follow the specifications of class 2 wiring.

3.3.2 Contactor and Circuit Breaker specification and wiring.

Molded-case circuit breaker/magnetic contactor

- Teco bears no responsibility to service for failures caused by the following conditions:
 - (1) A molded-case circuit breaker is not installed, or an improper or overrated breaker is used, between the power source and the inverter.
 - (2) A magnetic contactor, a phase capacitor, or a burst absorber is connected between the inverter and the motor.

model : S310-□□□-XXX	2P5	201	202
Molded-case circuit breaker made by Taian	50E 10A	50E 20A	50E 30A
Magnetic contactor (MC) made by Taian	CN-11		
Main circuit terminals (TM1)	Wire gauge 2.0 mm ² terminal screw M3		
Signal terminals (TM2)1~12	Wire gauge 0.75mm ² (# 18 AWG) terminal screw M2		
Signal terminals (TM3)1~3	Wire gauge 0.75mm ² (# 18 AWG) terminal screw M2		

- Use three-phase squirrel cage induction motor with capacity suitable for the inverter.
- If one inverter is driving several motors, the total current of all motors running simultaneously must be less than the rated current of the inverter, and each motor has to be equipped with a proper thermal relay.
- Do not add capacitive components, such as a phase capacitors, LC or RC, between the inverter and the motor.

3.3.3 Precautions for peripheral applications:

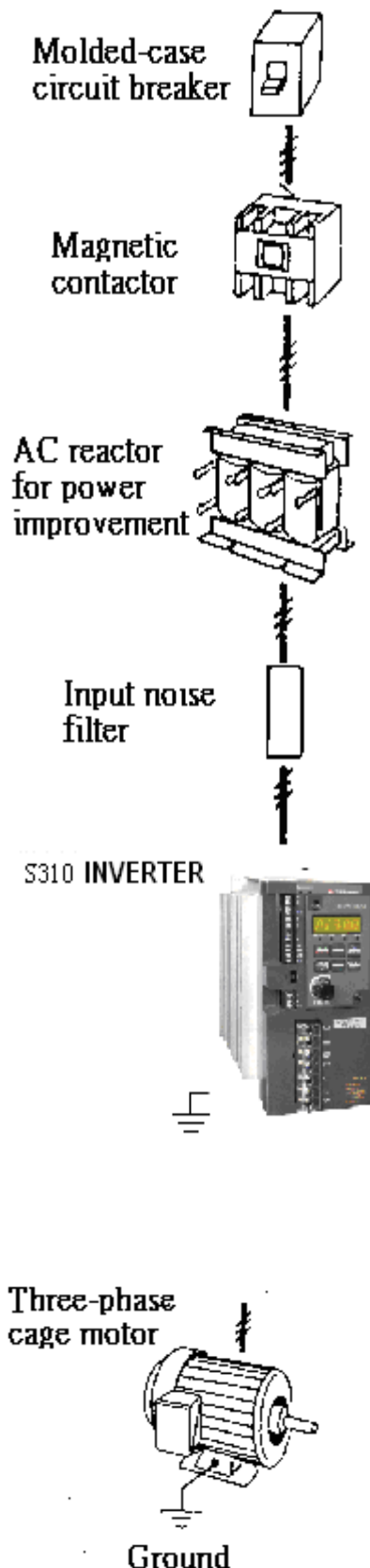
**Power supply:**

- Make sure the correct voltage is applied to avoid damaging the inverter.
- A molded-case circuit breaker or fused disconnect must be installed between the AC source and the inverter

Molded-case circuit breaker:

- Use a molded-case circuit breaker that conforms to the rated voltage and current of the inverter to control the power ON/OFF and protect the inverter.
- Do not use the circuit breaker as the run/stop switch for the inverter.

Leakage breaker:

- Install a leakage breaker to prevent problems caused by electric leakage and to protect personnel.
- Setting current should be 200mA or above and the operating time at 0.1 second or longer to prevent malfunctions.

Magnetic contactor:

- Normal operations do not need a magnetic contactor. However a contactor has to be installed in primary side when performing functions such as external control and auto restart after power failure, or when using a brake controller.
- Do not use the magnetic contactor as the run/stop switch of the inverter.

AC reactor for power quality improvement:

- When inverters below 200V class 15KW are supplied with high capacity (above 600KVA) power source or an AC reactor can be connected to improve the power performance.

Install fast action fuse:

- To ensure the safety of peripheral devices, please install fast action fuse. Regarding the specification, please refer to P3-4.

Input noise filter:

- A filter must be installed when there are inductive loads affecting the inverter

Inverter:

- Input power terminals L1, and L2 can be used in any sequence regardless of phase.
- Output terminals U, V, and W are connected to U, V, and W terminals of the motor. If the motor is reversed while the inverter is set to run forward, just swap any two terminals of U, V, and W.
- To avoid damaging the inverter, do not connect the input terminals U, V, and W to AC input power.
- Connect the ground terminal properly. 200V class: class 3 grounding, <math><100\Omega</math>.

Figure 3-3 Typical Installation Schematic

Make external connections according to the following instruction. Check connections after wiring to make sure all connections are correct. (Do not use the control circuit buzzer to check connections)

(A) Main circuit's wiring must be separated from other high voltage or high current power line to avoid noise interference. Refer to the figures below:

Figure 3-4 a) Installation Examples

- The inverter uses dedicated power line



- Add a noise filter or separation transformer when sharing the power line with other machines.

- the inverter shares the power line with other machines

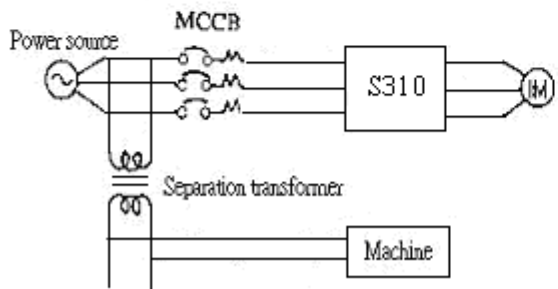
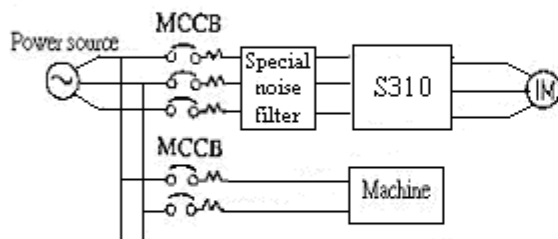

correct

- A general noise filter may not provide correct results

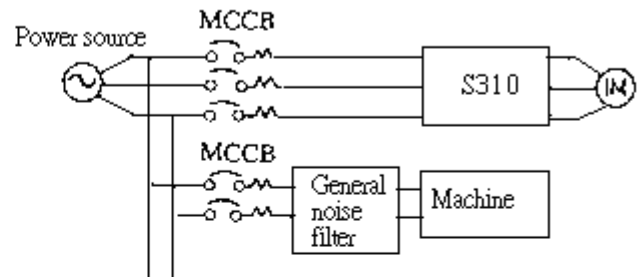

Incorrect

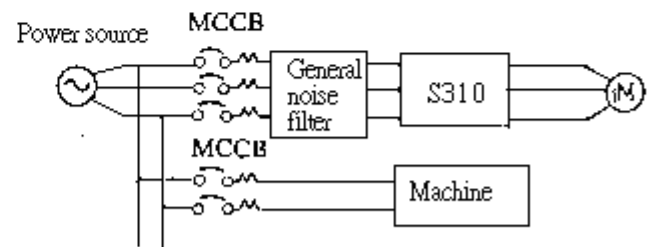

Incorrect

Figure 3-4b) Installation Examples using a filter and Isolation transformer

- A noise filter in the output of the main circuit can suppress conducted noise.
- To prevent radiated noise, the wires should be put in a metal pipe and distance from signal lines of other control equipment should be more than 30 cm.

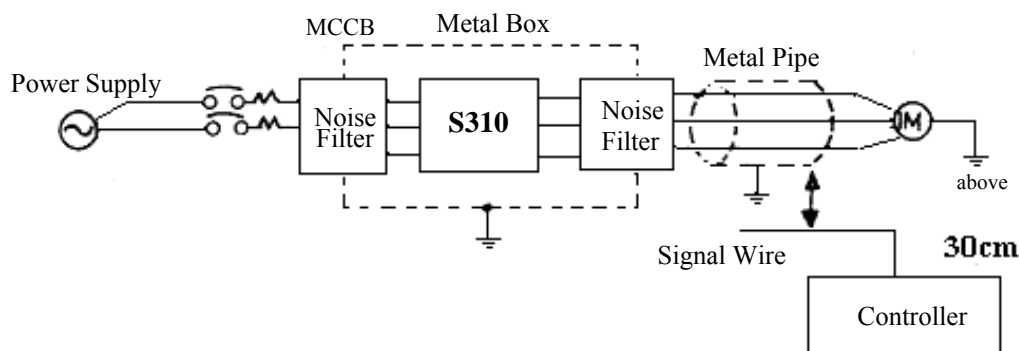

Figure 3-4c) Installation Examples with Adjacent Signal Conductors

- When the connection between the inverter and the motor is too long , consider the voltage drop of the cables.

Phase-to-phase voltage drop (V) = $\sqrt{3}$ ×resistance of wire (Ω/km)×length of line (m)×current×10⁻³.

- Carrier frequency must be adjusted based on the motor cable length.

Cable length between the inverter and the motor	Below 150ft	Below 300ft	Above 300ft
Recommended carrier frequency	Below 12KHz	Below 8KHz	Below 5KHz
Setting of parameter 10-03	12	8	5

(B) The control circuit wiring must be separated and routed away from the main circuit control line or other high voltage or current power lines to avoid noise interference

- To avoid erroneous operation caused by noise interference, shield the control circuit wiring with twisted-wires, and connect the shielded wire to a ground terminal. Refer to the figure below. The wiring distance should not exceed 50 meters.

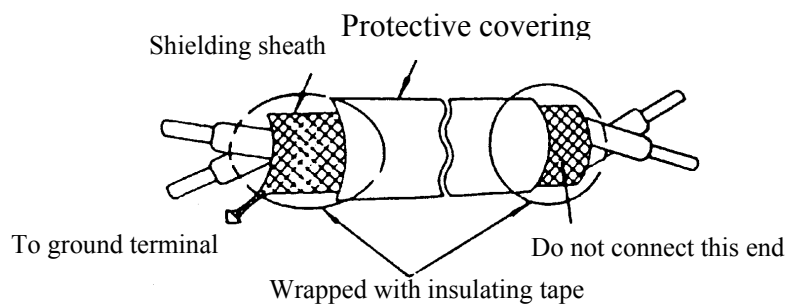
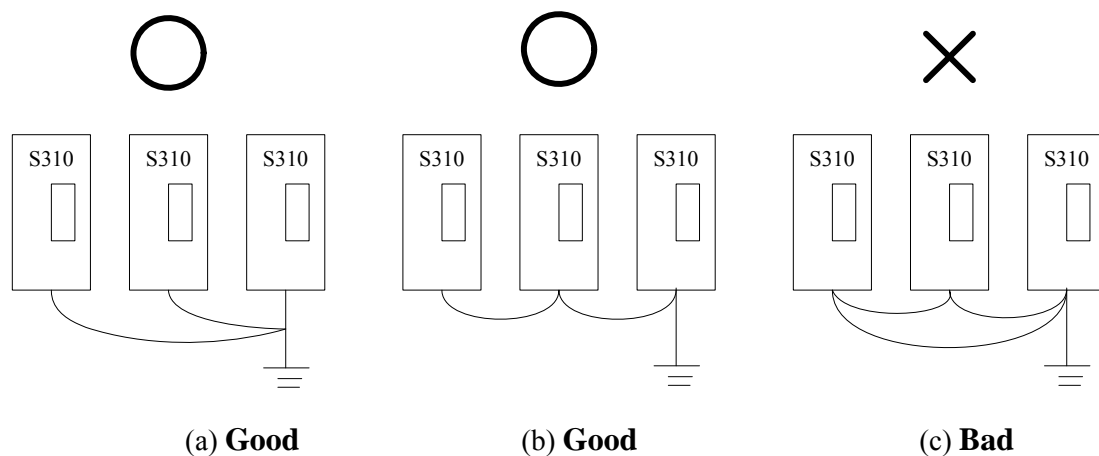

Figure 3-5 Control Cable requirements

(C) Inverter Ground terminal must be connected to installation ground correctly and according to the required local wiring regulations. For 200V class ground resistance should be 100Ω or less.

- Ground cable size must be according to the required local wiring regulations. the shorter the better.
- Do not share the ground of the inverter with other high current loads (welding machine, high power motor). Connect the terminals to their own ground.
- Do not make a loop when several inverters share a common ground point.

Figure 3-6 Grounding Examples



(D) To ensure maximum safety, use correct wire size for the main power circuit and control circuit. (According to the required local regulations)

(E) Verify that all wiring is correct, wires are intact, and terminal screws are secured.

3.4 Specifications

3.4.1 Product Specifications

Single / Three phase, 200-240V model

S310-□□□-XXX	2P5	201	202
Horsepower(HP)	0.5	1	2
Max Applicable Motor Output (KW)	0.4	0.75	1.5
Rated Output Current(A)	3.1	4.2	7.5
Rated Capacity(KVA)	0.88	1.60	2.9
Max. Input Voltage	Single Phase: 200~240V +10% -15% , 50/60Hz ± 5%		
Max. Output Voltage	Single Phase: 200~240V		
Input Current(A)	5.4	10.4	16
Net Weight (KG)	0.97		1.07
Net Weight (KG)(keypad)	1.0		1.1
Allowable momentary power loss time (second)	1.0	1.0	2.0

3.4.2 General Specifications

Item	S310	
Control Mode	V/F	
Frequency Control	Range	0.01~400.00 Hz
	Setting resolution	Digital: 0.01Hz, Analog: 0.06Hz/ 60Hz(10bits)
	Keypad setting	Set directly with ▲ ▼ keys or the VR on the keypad
	Display Function	Five digital LED and status indicator: display frequency / Inverter parameter/ Fault Log/ Program Version
	External signal setting	1. External potentiometer0-10V/ 0-20mA 2. Provides up/down controls, speed control or automatic procedure control with multifunctional contacts on the terminal block(TM2)
	Frequency Limit Function	Upper/lower frequency limits
General Control	Carrier frequency	1 ~ 12 kHz
	V/F pattern	6 fixed patterns, 1 programable curve
	Acc/Dec control	Acc/Dec time (0.1 ~ 3,600 seconds)
	Multifunction analog output	4 functions (refer to description on 2-12)
	Multifunction input	12 functions (refer to description on 01-00~01-04)
	Multifunction output	6 functions (refer to description on 01-09)
	Other Functions	Momentary Power Loss Restart, Overload Detection, 8 preset speeds, 2/3-wire Control, torque boost, Slip Compensation, Frequency Upper/ Lower Limit, Modbus slave and PC/PDA Link, Auto Restart.

Communication Control	<ol style="list-style-type: none"> 1. Control by RS485 2. One to one or one to many (RS485 ONLY) control. 3. BAUD RATE/STOP BIT/PARITY/bit can be set 	
Braking Torque	About 20% , standard model the specified external braking resistors can provide 100%	
Operation temperature	14-104°F(-10 ~ 40°C)	
Storage temperature	4-140°F(-20 ~ 60°C)	
Humidity	0 – 95% Relative Humidity(Non-condense)	
Vibration	1G (9.8m/s ²)	
Enclosure	IP20	
Protective Functions	FUSE protection	The motor stops after FUSE melt
	Over Voltage	200V class: DC Voltage > 410V
	Under Voltage	200V class: DC Voltage < 190V
	Momentary Power Loss Restart	Restart can be initiated with spin start .
	Other Function	Over torque detection, error contact control, reverse prohibit, prohibit for direct start after power up and error recovery.

3.5 Wiring diagram S310 series inverter

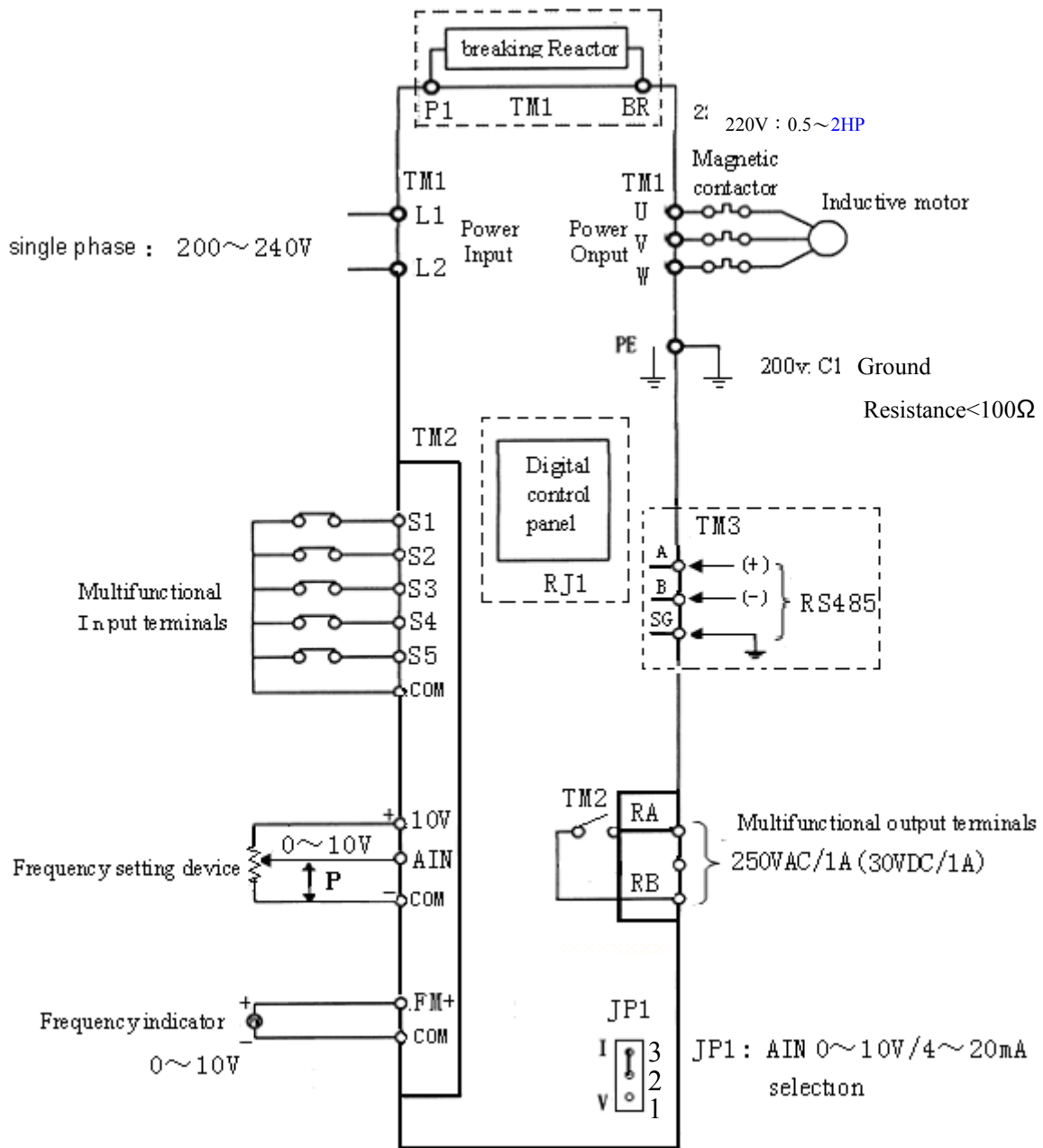

Figure 3-7 Wiring Diagram

Note 1: Please refer to description of main circuit terminals (P1, BR) and specification of braking resistor for value selection.

2: Dashed box built-in or none, please refer to CH2 Definition of model

3: Please avoid connecting output of inverter to the earth.

3.6 Description of connection terminals

Descriptions of main circuit terminals

Symbol	Description
L1	Main power input. single phase :L1 / L2
L2	
BR	Braking resistor connection terminal: Used in applications when it is required to stop a high inertia load rapidly. (refer to specifications of the braking resistor)
P1	
U	Inverter outputs
V	
W	

Descriptions of S310 control circuit terminals

Symbol	Description		
RB	Normal close contact	Multifunctional output terminals	Contact rated capacity: (250VAC/1A or30VDC/1A) Contact using description:(refer to parameters 01-09)
RA	Normal open contact		
10V	Frequency knob (VR) power source terminal (pin 3)		
AIN	Analog frequency signal input terminal (0~10VDC/4~20mA)		
COM	Common for digital input signal for S1~S5 input.		
FM+	The positive multifunction analog output signal for multifunction (refer to parameter 2-12 description), the signal for output terminal is 0-10VDC (below 2mA).		
S1	multifunction input terminals (refer to parameter 1-00~1-04 description)		
S2			
S3			
S4			
S5			
A	(+) RS485 communication applications		
B	(-) RS485 communication applications		
SG	Ground(RS485)		

200V class: 0.5 ~ 2HP

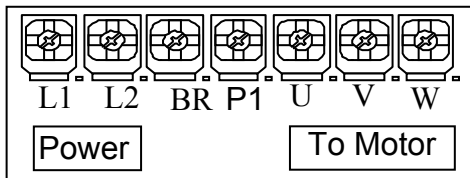

Figure 3-8 Power Input Locations

Descriptions of JUMPER function

JP2/JP3	Type of external signal	Remarks
	4~20mA analog signal	Effective when External control 00-05=2
	0~10VDC analog signal	

3.7 Outline Dimension (unit: mm)

(1) Frame1 : single phase S310-2P5/201-H1BCD

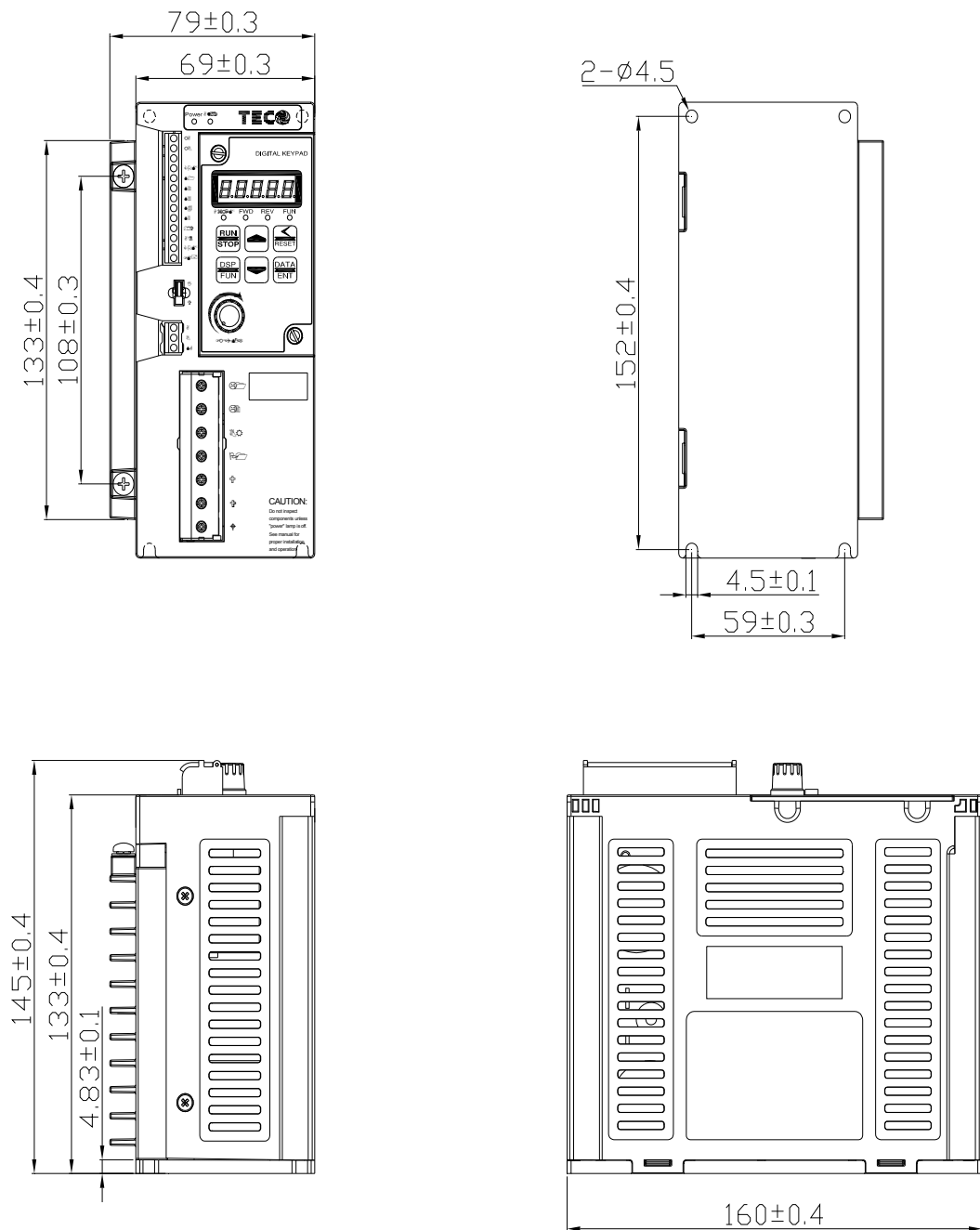

S310-2P5/201-H1BCD

Figure 3-9 Frame size 1 Dimensions

(2) Frame2 : Single phase : S310-2P5/201-1D

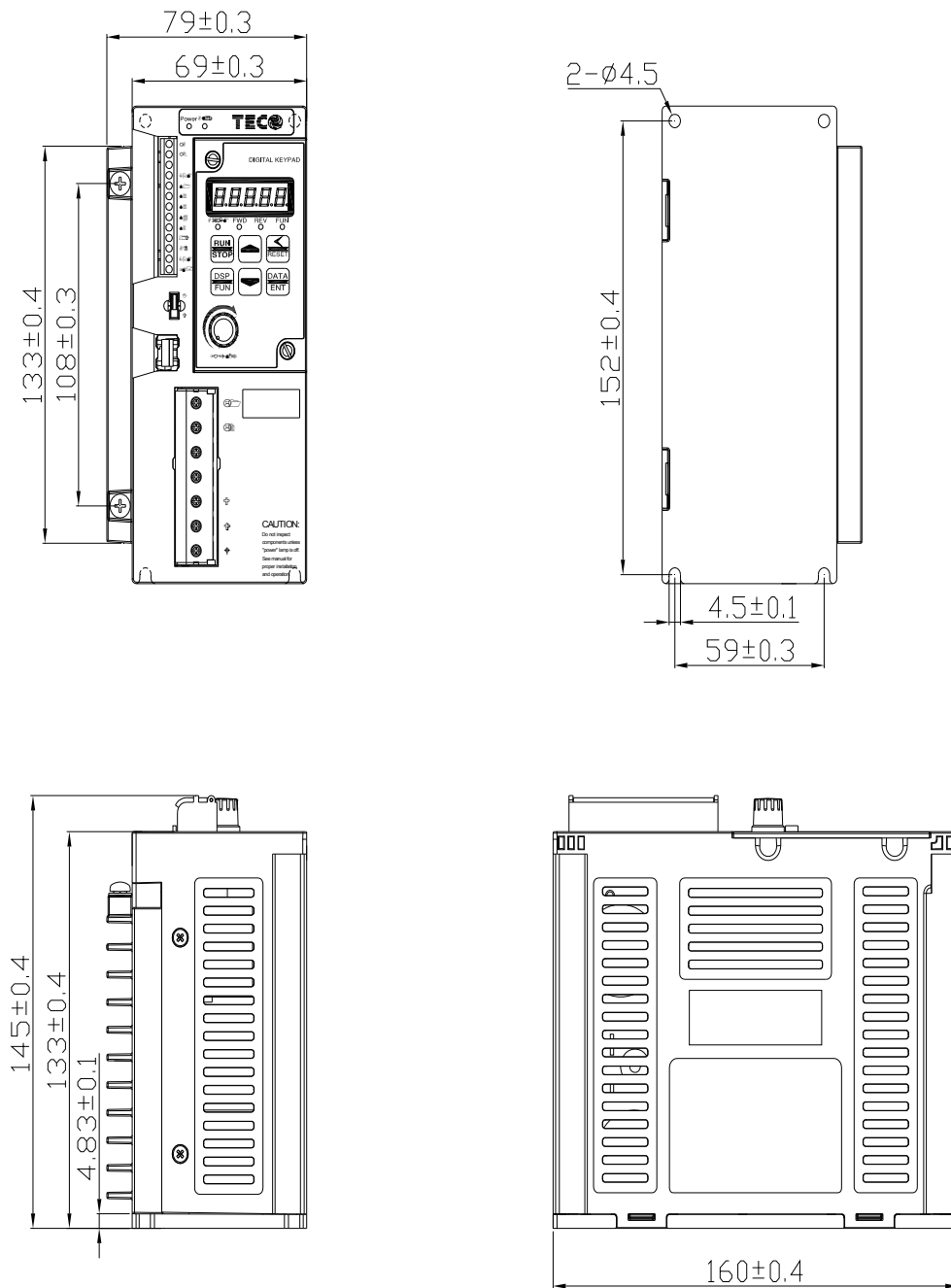

S310-2P5/201-H1D

Figure 3-10 Frame size 2 Dimensions

(3) Frame3 : Single phase : S310-2P5/201-H1

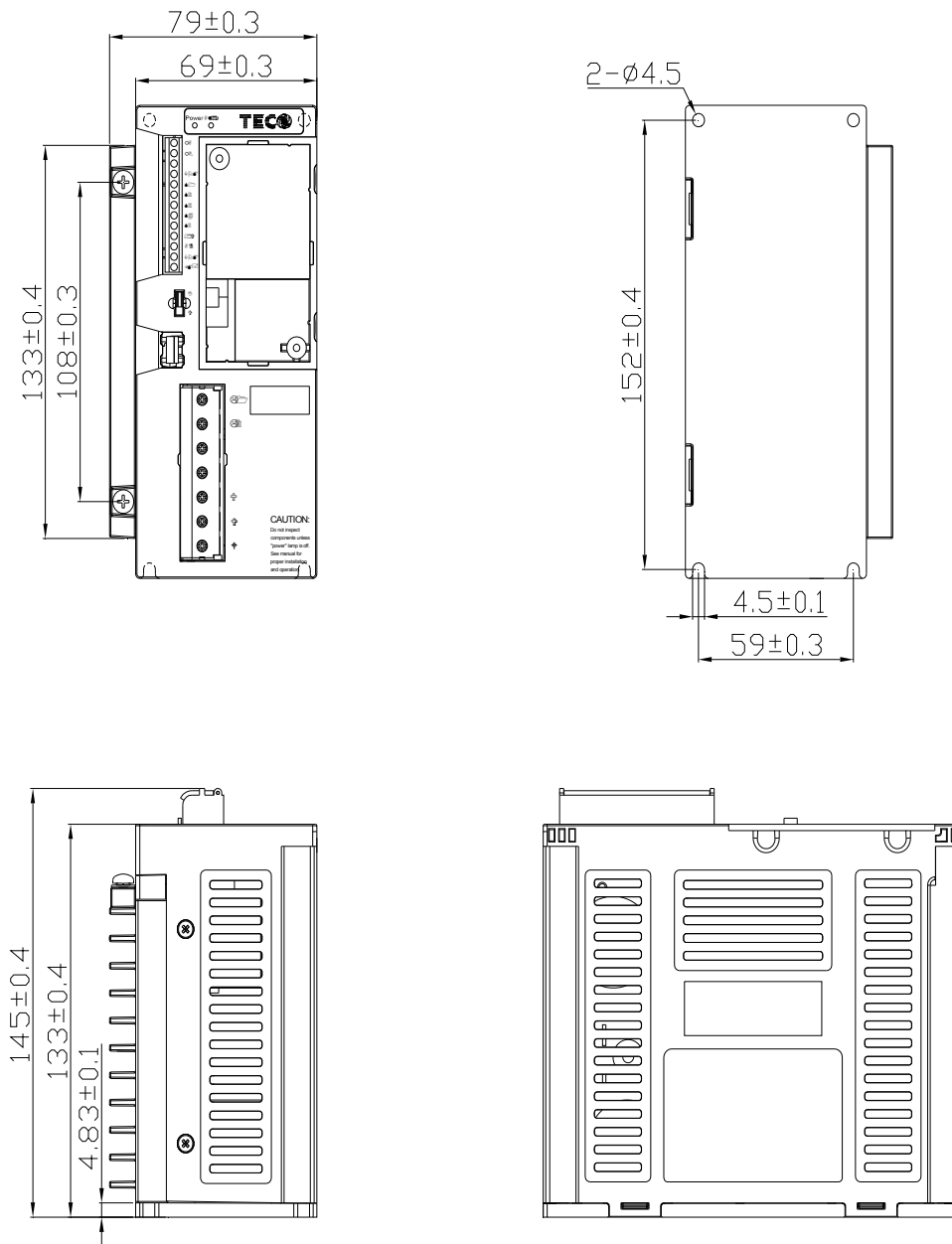

S310-2P5/201-H1

Figure 3-11 Frame size 3 Dimensions

Note :

model	unit	Breaking unit	RS485	keypad	fan
S310-201/2P5-H1D		×	×	√	×
S310-201/2P5-H1BCD		√	√	√	×
S310-201/2P5-H1		×	×	×	×

√ : built-in × : None

(4) Frame4 : Single phase : S310-202-H1BCD

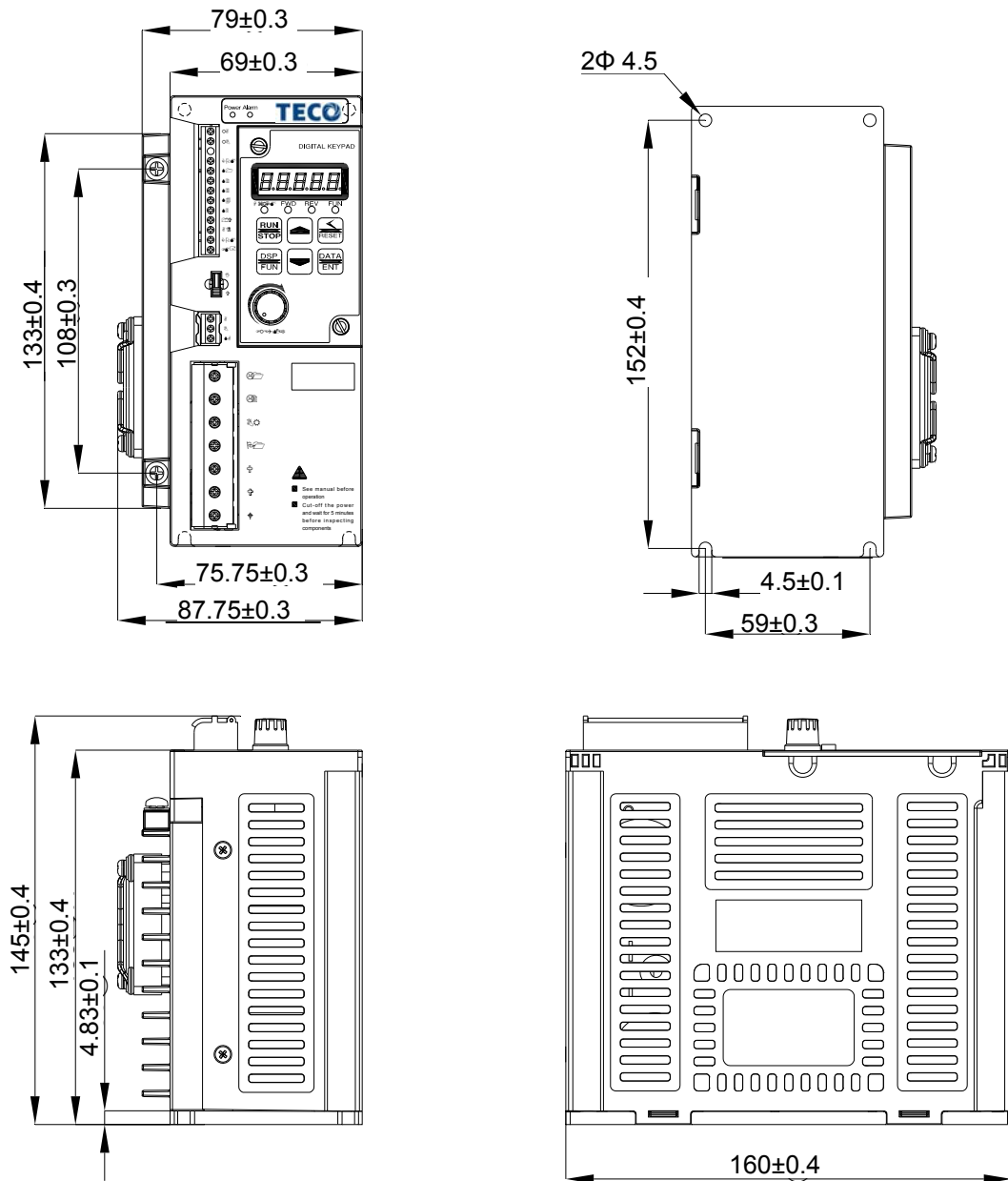

S310-202-H1BCD

Figure 3-12 Frame size 4 Dimensions

(5) Frame5 : Single phase : S310-202-H1D

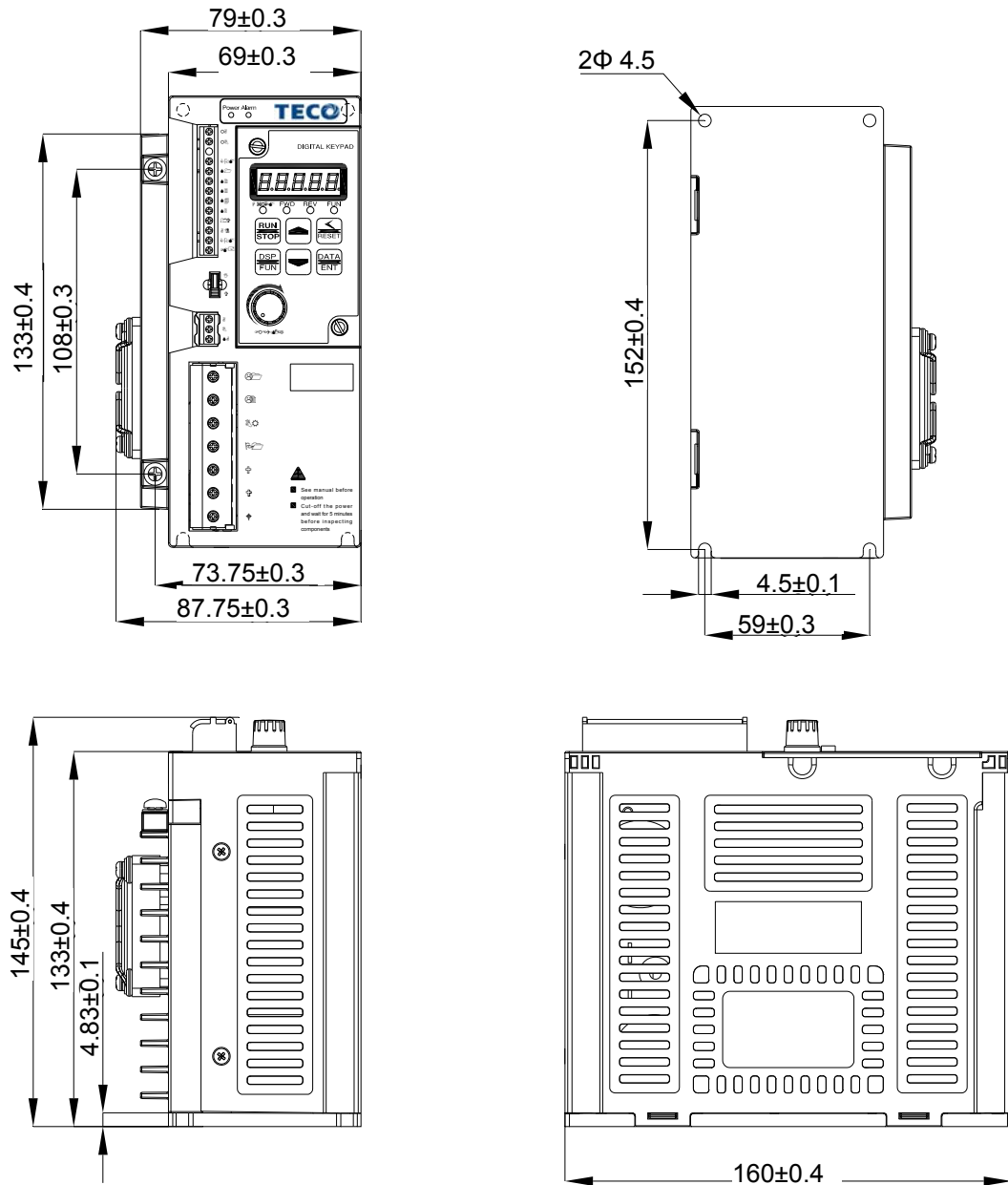

S310-202-H1D

Figure 3-13 Frame size 5 Dimensions

(6) Frame6 : Single phase : S310-202-H1

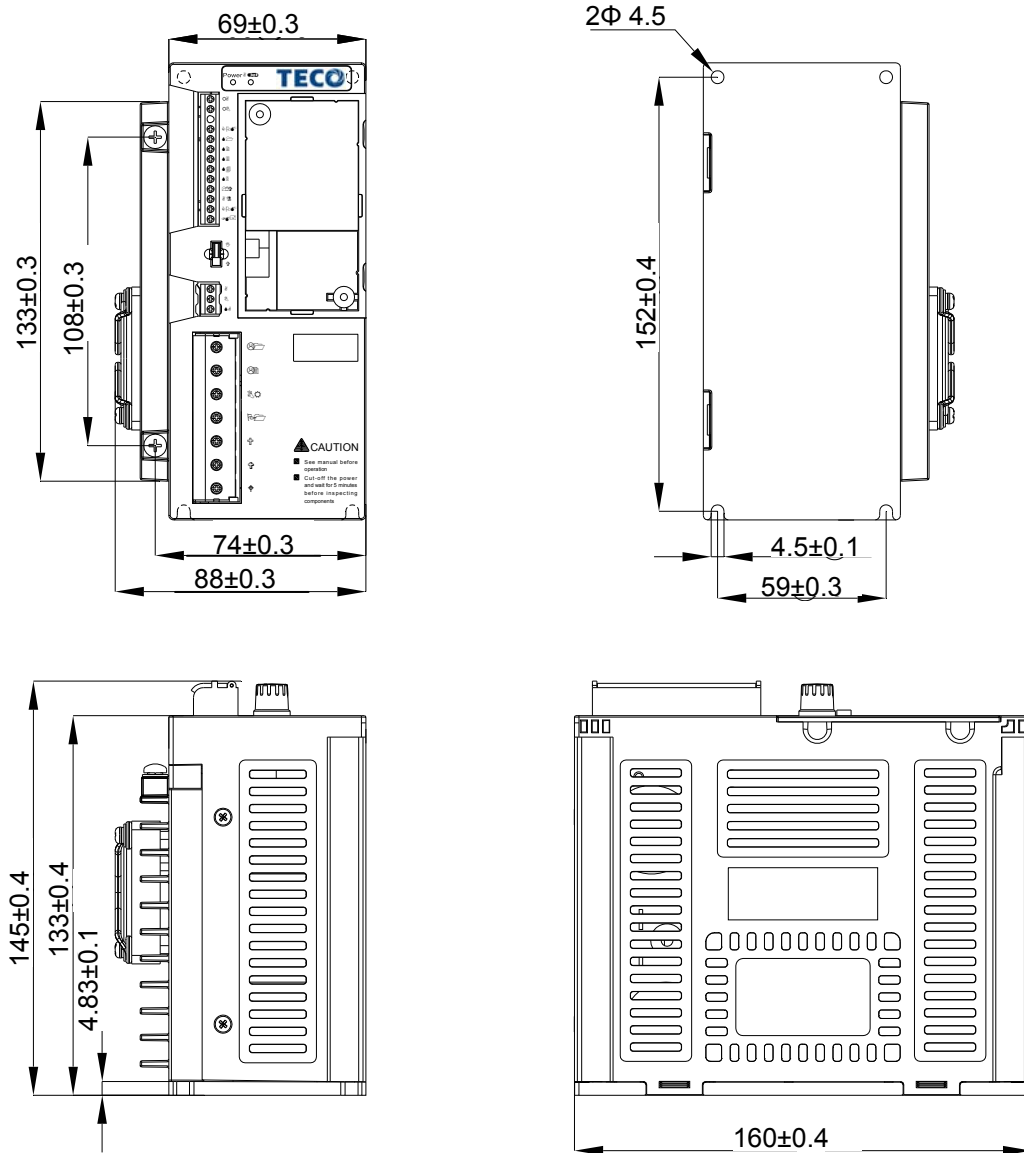

S310-202-H1

Figure 3-14 Frame size 6 Dimensions

Note:

model	unit	Breaking unit	RS485	keypad	fan
S310-202-H1D		×	×	√	√
S310-202-H1BCD		√	√	√	√
S310-202-H1		×	×	×	√

√:built-in ×:None

Chapter 4 Software Index

4.1 Keypad Description

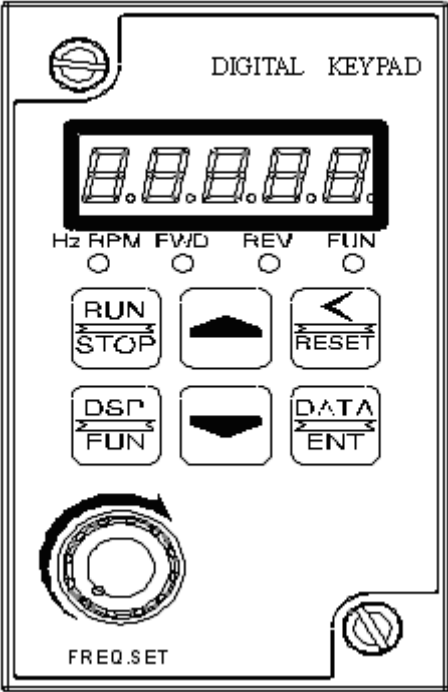

Figure 4-1 Keypad Layout

- 1. Four actions of FUN mode: Hz/RPM, and display of five 7-segment display. (Refer to operation description of the keypad).
- 2. FWD LED: Forward Direction, LED action (Flash while stopped, solid Lit during operation).
- 3. REV LED: Reverse Direction, LED action (Flash while stopped, solid Lit during operation).

⚠ Caution

To avoid keypad damage, do not operate it with a screwdriver or any sharp and hard tool.

4 Operation Instruction of the LED keypad

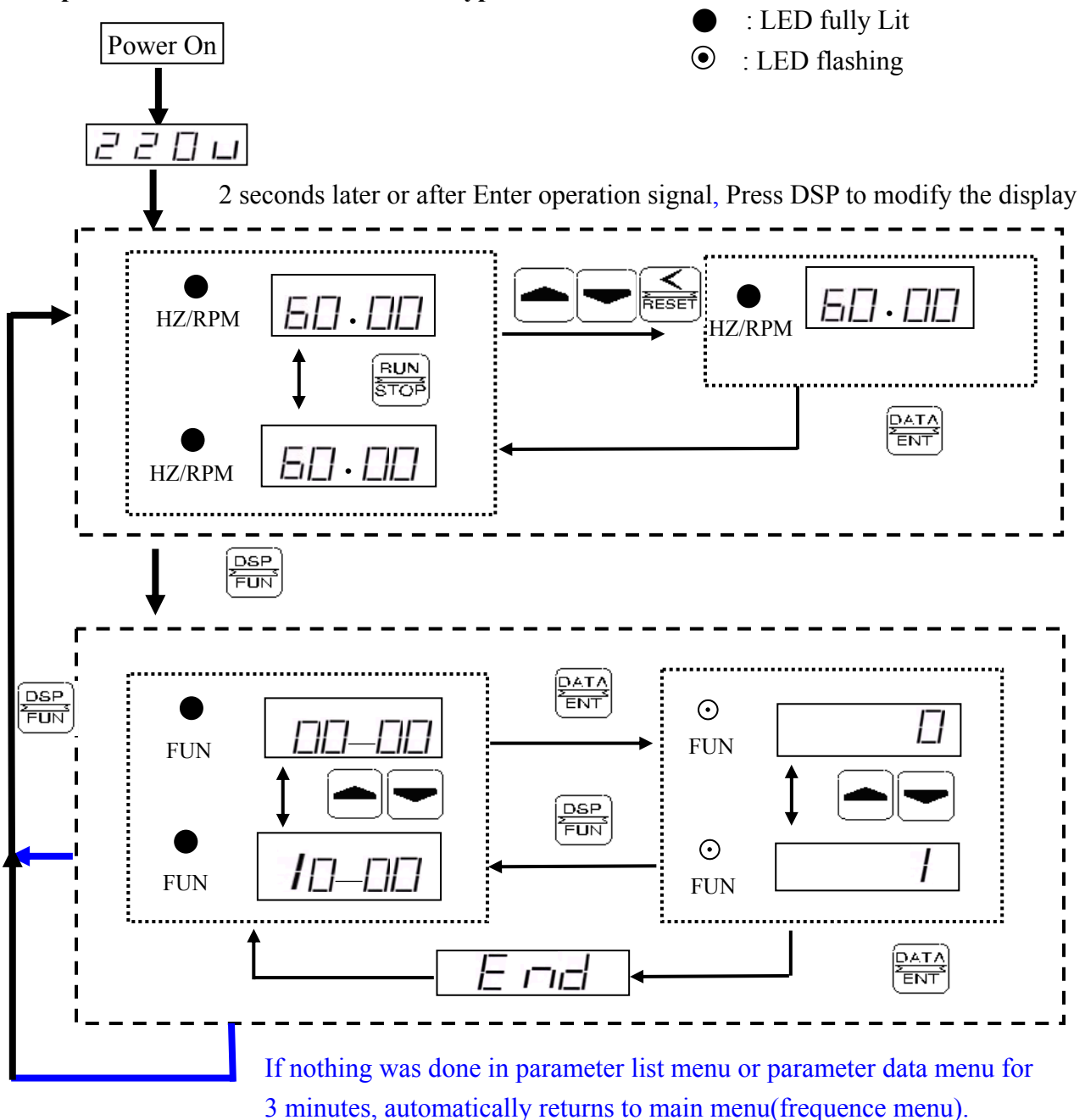

Figure 4-2 LED Keypad Operations Sequence

5.The instructions for the Power and Alarm LED of the inverter are as follows:

Power indicator light:

On power up, Power LED action, otherwise Power LED Turn off

Alarm indicator light: (note1:)

- a. When the inverter have mistakes which cannot be reseted, such as:
CTER,EPR,OH,LV,OV,OC , the Alarm LED flashes quickly
- b. When the inverter have mistakes which can be reseted, such as:
OH-C, OV-C, OC-S, OC-d, OC-C, OC-a, OL2, OL1, the Alarm LED flashes slowly

4.2 S310 Programmable Functions List

Parameter Group No.	Description
00-	The basic parameters group
01-	External terminal digital signal input function group
02-	External terminal analog signal input function group
03-	Preset Frequency function group
04-	Start/Stop command group
05-	V/F command group
07-	Protection function group
08-	Communication function group
10-	Assistant function group
11-	Keypad display group
12-	User parameter group
-13	Auto Run(Auto Sequencer) function group

0- The basic parameters group

Function Code No.	Description	Range/Code	Factory Setting	Remarks
00-00	-----	-----	-----	Reserved
00-01	Volts/Hz Patterns (V/F)	1~7	1/4	
00-02	Motor rotation	0 : Forward 1 : Reverse	0	*1
00-03	Main Run Command Source Selection	0: Keypad 1: External Run/Stop Control 2: Communication	0	
00-04	-----	-----	-----	Reserved
00-05	Main Frequency Command Source Selection	0: Keypad 1: Potentiometer on Keypad 2: External AI1 Analog Signal Input 3: Communication Control 4: Pulse Input	0	
00-07	Frequency Upper Limit (Hz)	0.01~400.00	50.00 /60.00	
00-08	Frequency Lower Limit (Hz)	0.01~399.99	0.00	
00-09	Acceleration Time 1(S)	0.1~3600.0	10.0	*1
00-10	Deceleration Time 1(S)	0.1~3600.0	10.0	*1
00-11	Operation modes for external terminals	0: Forward/Stop-Reverse/Stop 1: Run/Stop-Forward/Reverse 2: 3-Wire Control Mode-Run/Stop 3:4 -Wire pulse Control Mode-Run/Stop	0	
00-12	Jog Frequency (Hz)	1.00~25.00	2.00	*1
00-13	Jog Acceleration Time (MFIT) ((Seconds	0.1~25.5	0.5	*6*1
00-14	Jog Deceleration Time (MFIT) ((Seconds	0.1~25.5	0.5	*6*1

1- External terminal digital signal input function group

Function Code No.	Description	Range/Code	Factory Setting	Remarks
01-00	Multifunction Input Term. S1	0: Forward/Stop Command	0	
01-01	Multifunction Input Term. S2	1: Reverse/Stop Command	1	
01-02	Multifunction Input Term. S3	2: Preset Speed unit 1 (3-02)	5	
01-03	Multifunction Input Term. S4	3: Preset Speed unit 2 (3-03)	6	
01-04	Multifunction Input Term. S5	4: Preset Speed unit 3 (3-04) 5: Jog Command 6: Emergency Stop 7: Base Block 8: Reset 9: Auto _ Run Mode 10 : Catch up*6 11 : slow Down*6	8	
01-05	Catch up / slow Down Value	0 ~ 100(%)	20	*6
01-06	Multifunction terminal S1~ S5 confirm the scan times	1 ~ 200(x2ms)	10	
01-07~01-08	-----	-----	-----	Reserved
01-09	Output Relay RY1 Operation Mode	0: Run 1: Frequency Reached 2: Fault 3: Set Frequency 4: Frequency Threshold Level (> 1-11) - Frequency Reached Frequency Threshold Level (< 1-11) - Frequency Reached	0	
01-11	Frequency Output Setting (Hz)	0.00 ~ 400.00	0.00	*1
01-12	Frequency Detection Range	0.00~30.00	2.00	*1
01-13	S1~ S5 switch type select	xxxx0: S1 NO xxx1: S1 NC xxx0x: S2 NO xxx1x: S2 NC xx0xx: S3 NO xx1xx: S3 NC x0xxx: S4 NO x1xxx: S4 NC 0xxxx: S5 NO 1xxxx: S5 NC	00000	*6

※ “NO”: Normal open, “NC”: Normal close.

2- External terminal analog signal input function group

Function Code No.	Description	Range/Code	Factory Setting	Remarks
02-00	AIN analog Input signal type select	0: 0 ~ 10V 1: 4 ~ 20mA	0	
02-01	AIN Signal Verification Scan	1 ~ 200 (×2ms)	100	
02-02	AIN Gain (%)	0 ~200	100	*1
02-03	AIN Bias (%)	0 ~100	0	*1
02-04	AIN Bias Selection	0: Positive 1: Negative	0	*1
02-05	AIN Slope	0: Positive 1: Negative	0	*1
02-06~02-11 Reserved				
02-12	Analog Output Mode(FM+)	0: Output Frequency 1: Frequency Setting 2: Output Voltage 3: DC Bus Voltage	0	*1
02-13	Analog Output FM+ Gain (%)	0 ~200	100	*1

3-preset Frequency function group

Function CodeNo.	Description	Range/Code	Factory Setting	Remarks
03-00	Preset Speed Control mode Selection	0: common (Is uniform time(Acc1/Dec1) 1: special (is single time Acc0/Dec0~ Acc7/Dec7)	0	*1
03-01	Preset Speed 0 (Hz)	0.00 ~ 400.00	5.00	Keypad Freq
03-02	Preset Speed1 (Hz)	0.00 ~ 400.00	5.00	*1
03-03	Preset Speed2 (Hz)	0.00 ~ 400.00	10.00	*1
03-04	Preset Speed3 (Hz)	0.00 ~ 400.00	20.00	*1
03-05	Preset Speed4 (Hz)	0.00 ~ 400.00	30.00	*1
03-06	Preset Speed5 (Hz)	0.00 ~ 400.00	40.00	*1
03-07	Preset Speed6 (Hz)	0.00 ~ 400.00	50.00	*1
03-08	Preset Speed7 (Hz)	0.00 ~ 400.00	60.00	*1
03-09	-----	-----	-----	Reserved
03-10	-----	-----	-----	Reserved
03-11	-----	-----	-----	Reserved
03-12	-----	-----	-----	Reserved
03-13	-----	-----	-----	Reserved
03-14	-----	-----	-----	Reserved
03-15	-----	-----	-----	Reserved
03-16	-----	-----	-----	Reserved
03-17	Preset Speed0-Acctime (s)	0.1 ~ 3600.0	10.0	*1
03-18	Preset Speed0-Dectime (s)	0.1 ~ 3600.0	10.0	*1
03-19	Preset Speed1-Acctime (s)	0.1 ~ 3600.0	10.0	*1
03-20	Preset Speed1-Dectime (s)	0.1 ~ 3600.0	10.0	*1
03-21	Preset Speed2-Acctime (s)	0.1 ~ 3600.0	10.0	*1
03-22	Preset Speed2-Dectime (s)	0.1 ~ 3600.0	10.0	*1
03-23	Preset Speed3-Acctime (s)	0.1 ~ 3600.0	10.0	*1
03-24	Preset Speed3-Dectime (s)	0.1 ~ 3600.0	10.0	*1
03-25	Preset Speed4-Acctime (s)	0.1 ~ 3600.0	10.0	*1
03-26	Preset Speed4-Dectime (s)	0.1 ~ 3600.0	10.0	*1
03-27	Preset Speed5-Acctime (s)	0.1 ~ 3600.0	10.0	*1
03-28	Preset Speed5-Dectime (s)	0.1 ~ 3600.0	10.0	*1
03-29	Preset Speed6-Acctime (s)	0.1 ~ 3600.0	10.0	*1
03-30	Preset Speed6-Dectime (s)	0.1 ~ 3600.0	10.0	*1
03-31	Preset Speed7-Acctime (s)	0.1 ~ 3600.0	10.0	*1
03-32	Preset Speed7-Dectime (s)	0.1 ~ 3600.0	10.0	*1

04-start/stop command group

Function Code No.	Description	Range/Code	Factory Setting	Remarks
04-00	-----	-----	-----	Reserved
04-01	Stopping Method Selection	0: Enhanced braking capacity 1: Coast to stop	0	
04-02	-----	-----	-----	Reserved
04-03	Momentary Power Loss and Restart	0: Momentary Power Loss and Restart disable 1: Momentary power loss and restart enable while CPU is operating. (According to the capacity of DC power)	0	
04-04~ 04-07	-----	-----	-----	Reserved
04-08	Reset Mode Setting	0: Enable Reset Only when Run Command is Off 1: Enable Reset when Run Command is On or Off	0	
04-09	Direct Running After Power Up	0: Enable Direct running after power up 1: Disable Direct running after power up	1	
04-10~ 04-14	-----	-----	-----	Reserved
04-15	DC Injection Brake Start Frequency (Hz) @stopped	0.10 ~ 10.00	1.50	
04-16	DC Injection Brake Level (%) @Stopped	0 ~ 20	5	
04-17	DC Injection Brake Time (Seconds) @stopped	0.0 ~ 25.5	0.5	
04-18	DC Injection Brake @running	0: DC Injection Brake @running enable 1: DC Injection Brake @ running disable	0	*6

05-V/F command group

Function Code No.	Description	Range/Code	Factory Setting	Remarks
05-00	Volts/Hz Curve Modification(Torque Boost) (%)	0 ~ 30.0	0.0	
05-01	-----	-----	-----	Reserved
05-02	Motor rated Slip Compensation (%)	0.0 ~ 100.0	0.0	
05-03	v/f max voltage	198.0~256.0	220.0	
05-04	Maximum Frequency (Hz)	0.20 ~ 400.00	50.00/60.00	
05-05	Maximum Frequency Voltage Ratio (%)	0.0 ~ 100.0	100.0	
05-06	Medium Frequency2 (Hz)	0.10 ~ 400.00	25.00/30.00	
05-07	Medium Frequency Voltage Ratio2 (%)	0.0 ~ 100.0	50.0	
05-08	Medium Frequency1 (Hz)	0.10 ~ 400.00	10.00/12.00	
05-09	Medium Frequency Voltage Ratio1 (%)	0.0 ~ 100.0	20.0	
05-10	Minimum Frequency (Hz)	0.10 ~ 400.00	0.50/0.60	
05-11	Minimum Frequency Voltage Ratio (%)	0.0 ~ 100.0	1.0	

07-Protection function group

Function Code No.	Description	Range/Code	Factory Setting	Remarks
07-00	Trip Prevention Selection	xxxx0: Enable Trip Prevention During Acceleration xxxx1: Disable Trip Prevention During Acceleration xxx0x: Enable Trip Prevention During Deceleration xxx1x: Disable Trip Prevention During Deceleration xx0xx: Enable Trip Prevention in Run Mode xx1xx: Disable Trip Prevention in Run Mode x0xxx: Enable over voltage Prevention in Run Mode x1xxx: Disable over voltage Prevention in Run Mode	00000	
07-01	Trip Prevention Level During Acceleration (%)	50 ~ 200	200	
07-02	Trip Prevention Level During Deceleration (%)	50 ~ 200	200	
07-03	Trip Prevention Level In Run Mode (%)	50 ~ 200	200	
07-04	over voltage Prevention Level in Run Mode	80 VDC ~ 100VDC	100	
07-05	Electronic Motor Overload Protection Operation Mode	0: Enable Electronic Motor Overload Protection 1: Disable Electronic Motor Overload Protection	1	
07-06	Motor Rated Current ((Amp AC	-----		*6
07-13	OH over heat Protection ((cooling fan control	Auto (Depends on temp.) 1: :0 Operate while in RUN mode 2: Always Run Disabled :3	1	*6

08-Communication function group

Function Code No.	Description	Range/Code	Factory Setting	Remarks
08-00	Assigned Communication Station Number	1~ 32	1	*2*3
08-01	Communication mode	0: RTU 1: ASCII	-----	Reserved
08-02	Baud Rate Setting (bps)	0:4800 1:9600 2:19200 3:38400	2	*2*3
08-03	Stop Bit Selection	0:1 Stop Bit 1:2 Stop Bits	0	*2*3
08-04	Parity Selection	0:Without Parity 1:With Even Parity 2:With Odd Parity	0	*2*3
08-05	Data Format Selection	0: 8-Bits Data 1: 7-Bits Data	0	*2*3
08-06	Communication time-out detection time	0.0 ~ 25.5	0.0	
08-07	Communication time-out operation selection	0:Deceleration to stop 1:Coast to stop 2: continue operating.	0	
08-08	Err6 fault tolerance times	1 ~ 20	3	

10-Assistant function group

Function Code No.	Description	Range/Code	Factory Setting	Remarks
10-00	-----	-----	-----	Reserved
10-01	Reverse operation control	0: Reverse command is enabled 1: Reverse command is disabled	0	
10-02	-----	-----	-----	Reserved
10-03	Carrier Frequency (kHz)	1~ 12	5	
10-04	Carrier mode Selection	0: Carrier mode0 1: Carrier mode1 2: Carrier mode2	1	
10-16	AVR Control	0: AVR function effective 1: AVR function ineffective	0	*6

11-Keypad display group

Function Code No.	Description	Range/Code	Factory Setting	Remarks
11-00	Display Mode	xxxx0: Disable Motor Current Display xxxx1: Enable Motor Current Display xxx0x: Disable Motor Voltage Display xxx1x: Enable Motor Voltage Display xx0xx: Disable Bus Voltage Display xx1xx: Enable Bus Voltage Display x0xxx: Disable temperature Display x1xxx: Enable temperature Display	00000	*1
11-01	Custom Units (Line Speed) Value	0 ~ 65535	1500/1800	*1
11-02	Custom Units (Line Speed) Display Mode	0: Drive Output Frequency is Displayed 1: Line Speed is Displayed in Integer (xxxxx) 2: Line Speed is Displayed with One Decimal Place (xxxx.x) 3: Line Speed is Displayed with Two Decimal Places (xxx.xx) 4: Line Speed is Displayed with Three Decimal Places (xx.xxx)	0	*1

12-User parameter group

Function Code No.	Description	Range/Code	Factory Setting	Remarks
12-00	Drive Horsepower Code		-----	*3
12-01	Software Version	-----	-----	*3
12-02	Fault Log (Last 3 Faults)		-----	*3
12-03~12-05	-----	-----	-----	Reserved
12-06	Reset Drive to Factory Settings	1150: Reset to the 50Hz factory setting 1160: Reset to the 60Hz factory setting	0000	
12-07	Parameter Lock	0: Enable all Functions 1: 03-01~03-08 cannot be changed 2: All Functions cannot be changed Except 03-01~ 03-08 3: Disable All Function	0	*6

13-Auto Run function group

Function Code No.	Description	Range/Code	Factory Setting	Remarks
13-00	Auto Run(sequencer) mode selection	0: Disabled. 1: Single cycle. (Continues to run from the unfinished step if restarted). 2: Periodic cycle. (Continues to run from the unfinished step if restarted). 3: Single cycle, then holds the speed Of final step to run. (Continues to run from the unfinished step if restarted). 4: Single cycle. (starts a new cycle if restarted). 5: Periodic cycle. (starts a new cycle if restarted). 6: Single cycle, then hold the speed of final step to run. (starts a new cycle if restarted).	0	
13-01	Auto _ Run Mode Frequency Command 1	0.00 ~ 400.00 (Hz)	0.00	
13-02	Auto _ Run Mode Frequency Command 2			
13-03	Auto _ Run Mode Frequency Command 3			
13-04	Auto _ Run Mode Frequency Command 4			
13-05	Auto _ Run Mode Frequency Command 5			
13-06	Auto _ Run Mode Frequency Command 6			
13-07	Auto _ Run Mode Frequency Command 7			
13-08~13-15	Reserved		Reserved	
13-16	Auto _ Run Mode Running Time Setting 0	0.0 ~ 3600.0 (second)	0.0	
13-17	Auto _ Run Mode Running Time Setting 1			
13-18	Auto _ Run Mode Running Time Setting 2			
13-19	Auto _ Run Mode Running Time Setting 3			
13-20	Auto _ Run Mode Running Time Setting 4			
13-21	Auto _ Run Mode Running Time Setting 5			
13-22	Auto _ Run Mode Running Time Setting 6			
13-23	Auto _ Run Mode Running Time Setting 7		Reserved	
13-23~13-31	Reserved		Reserved	
13-32	Auto _ Run Mode Running Direction 0	0:stop 1: forward	0	
13-33	Auto _ Run Mode Running Direction 1	2: reverse		

13-34	Auto_Run Mode Running Direction 2			
13-35	Auto_Run Mode Running Direction 3			
13-36	Auto_Run Mode Running Direction 4			
13-37	Auto_Run Mode Running Direction 5			
13-38	Auto_Run Mode Running Direction 6			
13-39	Auto_Run Mode Running Direction 7			

- ※Notes: *1 Can be modified during run
 *2 cannot be modified while communication is active
 *3 do not change while making factory setting
 *4 the parameter will be changed by replacing model
 *5 only for version 1.1 and above
 *6 only for version V1.2 and above

4.3 Parameter Function Description

Group0- The basic parameters group

00-01:Volts/Hz Patterns (V/F) = 1 ~ 7

1.00-01=1~6 F Patt V /ern. (Refer to group5), 00-01=7 Flexiable V/F pattern.

00-02:Motor rotation = 0:forward =1:reverse

Note: when 00-01 is set to 1, 00-02 is not set to 1, keypad display "LOC".

00-03: Main Run Command Source Select

=0:Keypad =1: External Run/Stop Control =2: Communication

1. 00-03=0, the inverter is controlled by the keypad.

2. 00-03=1, the inverter is controlled by the external terminals, and the Stop key for emergency stop is operational.

※Note:00-03, please refer to parameter 04-03 for detailed description in order to ensure safety of operators and machines.

3. 00-03=2, the inverter is controlled by Communication.

00-05: Main Frequency Command Source Select

=0: UP/DOWN of Keypad =1:Potentiometer on Keypad

=2: External AIN Analog Signal Input

=3: External Up/Down Frequency Control

1. The priority in reading frequency is Jog> preset speed> ▲▼ on keypad or Up / Down or External AIN Analog Signal Input or communication control.

00-07: Frequency Upper limit(Hz) =0.01 ~ 400.00

00-08: Frequency Lower limit(Hz) =0.01 ~ 400.00

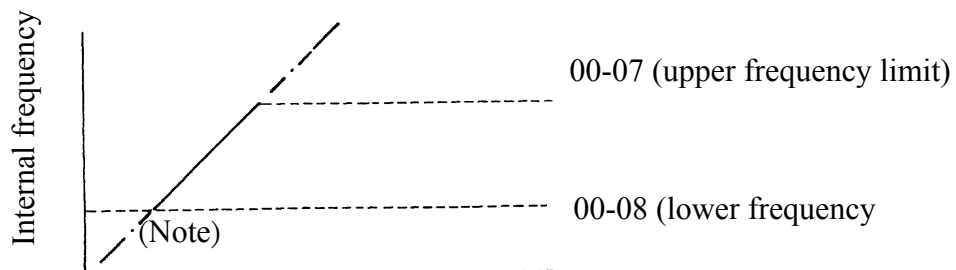

Figure 4-3 Frequency reference limits

※Note: When 00-08 = 0 Hz and frequency command is 0 Hz; the inverter will stop at 0 speed.

When 00-08 > 0 Hz and frequency command \leq 00-08, the inverter will output the 00-08 preset value.

00-09: Acceleration time (S) =0.1 ~ 3600.0

00-10: Deceleration time (S) =0.1 ~ 3600.0

1. Formula for calculating acceleration and deceleration time: The denominator is base on the rated frequency of motor.

$$\text{acceleration time} = \frac{00-09 \times \text{preset frequency}}{05-04}$$

$$\text{deceleration time} = \frac{00-10 \times \text{preset frequency}}{05-04}$$

00-11: Operation modes for external terminals

- =0: Forward/stop-reverse/stop** **=1: Run/stop-forward/reverse**
- =2: 3-wire control mode -run/stop** **=4: 4-wire control mode -run/stop**

- 1.) When operation command 00-03 = 1 (external terminal), 00-11 is valid.
- 2.) When operation command 00-03 = 1 (external terminal control), the stop button for emergency is available.
- 3.) That both forward and reverse commands are ON will be treated as STOP.

1、00-11 = 0, Control mode is as below:

2、00-11 =1, Control mode is as below:



Figure 4-4 Terminal Board Drive Operation Modes

3、00-11 = 2, Control mode is as below:

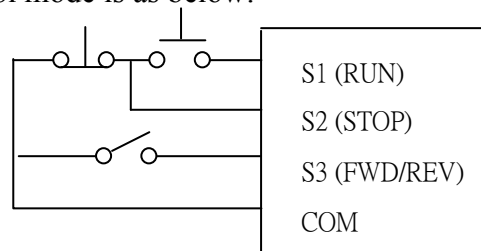

Figure 4-5 3-Wire start/stop wiring

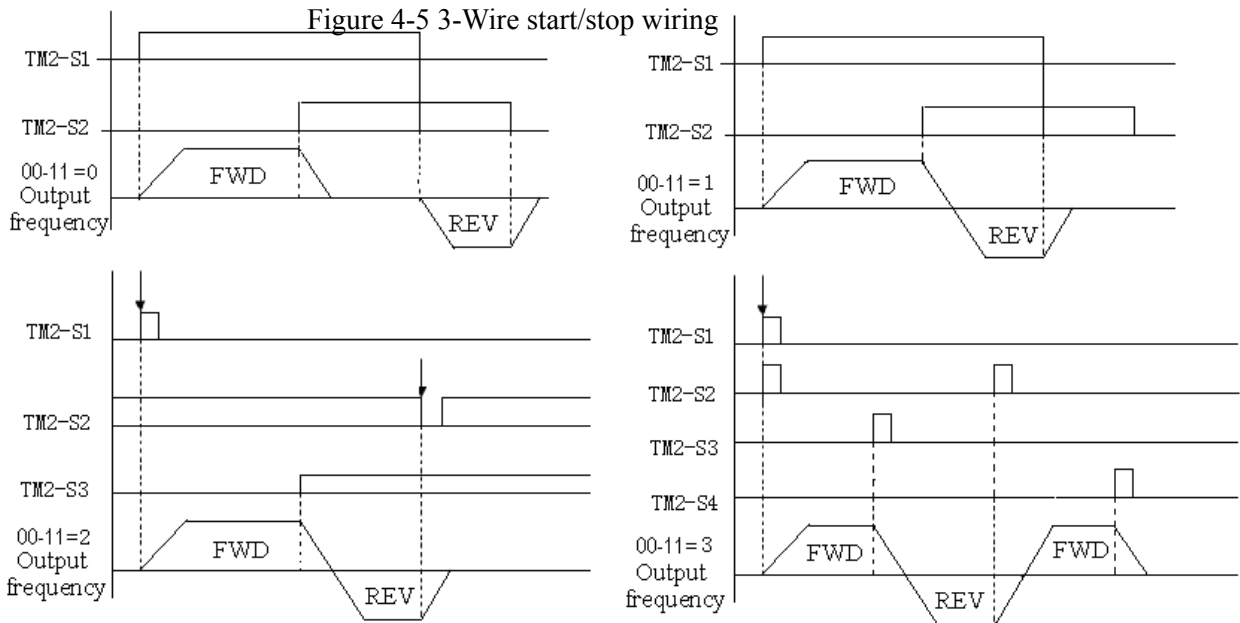

Figure 4-6 Drive start/stop operation sequences

- ※Note: 1.As 3 wire control mode is selected, the terminal S1, S2 and S3 is not controlled by 01-00, 01-01 and 01-02.
2. 10-01=1, the reverse command is unavailable.
- 3.As 4 wire control mode is selected, the terminal S1, S2 and S3, S4 is not controlled by 01-00, 01-01 and 01-02, 01-03.

00-12: Jog Frequency (Hz) =1.00 ~ 25.00

00-13: Jog Acceleration Time (MFIT) (Seconds) =0.1 ~ 25.5

00-14: Jog Deceleration Time (MFIT) (Seconds) =0.1 ~ 25.5

Group1- External terminal digital signal input function group

Multifunction input terminals (TM2 S1-S5) controlling:

- 01-00~04:**
- =0: Forward/Stop Command**
 - =1: Reverse/Stop Command**
 - =2: Preset Speed unit 0 (3-02)**
 - =3: Preset Speed unit 1 (3-03)**
 - =4: Preset Speed unit 2 (3-05)**
 - =5: JOG Command**
 - =6: Emergency Stop**
 - =7: Base Block**
 - =8: reset**
 - =9: Auto _ Run Mode**
 - =10: Catch up**
 - =11: Slow Down**

1) The terminals S1- S5 on terminal block (TM2) are multifunction input terminals. The 9 functions shown above can be set for these terminals.

2) Function Description for 1-00~04:

A. 01-00~04=0/1(Forward/Reverse/Stop)

As forward command is ON , the inverter runs and stops when the command is OFF. The 1-00 factory setting is forward.

As reverse command is ON, the inverter runs and stops when the command is OFF. The 1-01 factory setting is reverse.

B. 01-00~04=2/3/4 (Frequency Command 1/2/4at 3-02/3-03/3-05)

When External multifunction input terminals are ON, the inverter is operates at the preset speed and the duration is determined by the time the input is ON. The corresponding preset frequency will be according to preset value of parameters 3-01 to 3-08 and in relation to the operation of input terminals 2 to 4. As shown in the table below:

Output frequency preset value	Multifunction terminal 3 Preset value =4	Multifunction terminal 2 Preset value =3	Multifunction terminal 1 Preset value =2
3-01	0	0	0
3-02	0	0	1
3-03	0	1	0
3-04	0	1	1
3-05	1	0	0
3-06	1	0	1
3-07	1	1	0
3-08	1	1	1

C. 01-00~04=5(JOG)

When Jog operation, is selected, the inverter operates at the Jog acceleration and deceleration times. The corresponding jog frequency parameter is shown below:

The priority order of frequency: Jog Speed→Preset Speed→Keypad frequency or external frequency signal

D. 01-00~04=6: External Emergency Stop.

The inverter will decelerate to stop by 00-10 setting and Flash E.S as the emergency stop signal is received regardless of 04-01 setting. After the emergency stop signal is removed, turn the

RUN switch OFF and then ON again, or press the run key in keypad mode, the inverter will restart again up and ramps up to the command frequency.

E. 01-00~05=7: Base Block

The inverter immediately stops output, and the motor does a Coast with flashing B.B.

F. 01-00~05=8(Reset Command)

The Reset command is same as the Reset Key on the panel. When the command is OFF, the inverter does not respond.

G. 01-00~05=9(Auto _ Run Mode)

Set 01-00=9, when the input terminals are ON, the inverter is operates at the Auto _ Run Mode.

H. 01-00~04=10/11(Catch up/Slow Down)

Increases or Reduces reference value by percentage (relative) set in par. 01-05 Catch up/slow Down Value.

01-05: Catch up / slow Down Value	=0~100%
--	----------------

Enter a percentage (relative) value to be either added to or deducted from the actual reference for Catch up or Slow down respectively. actual input frequency command = input frequency + input frequency × (01-05 setting).

Digital /Analog input signal scan times:	
01-06: Multifunction terminal S1 ~ S5 confirm the scan times	=1 ~ 200(x2ms)

1. TM2 terminal is used for scanning. If there are the same signals continuously input for N times, the inverter will treat the signal as normal. During the signal evaluation, if the scan times are less than N, the signal will be treated as noise. 2. Each scan period is 8ms.
3. The user can specify the scan times interval duration according to the noise environment. If the noise is serious, increase the value of 01-06, however the response will be slower.

Multifunction output terminals control:	
01-09: Output Relay RY1 Operation Mode (R1C,R1B,R1A terminal)	
=0: Run	=1: Frequency Reached
=2: Fault	=3: Set Frequency (01-11 ±01-12)
=4: Frequency Threshold Level(> 1-11) - Frequency Reached	
=5: Frequency Threshold Level (< 1-11) - Frequency Reached	
01-11: Frequency Reached Output Setting	=0.00 ~ 400.00Hz
01-12: Frequency Detection Range	=0.00 ~ 30.00Hz

01-09/10= 3: Arbitrary frequency consistency Fout = 01-11 ±01-12

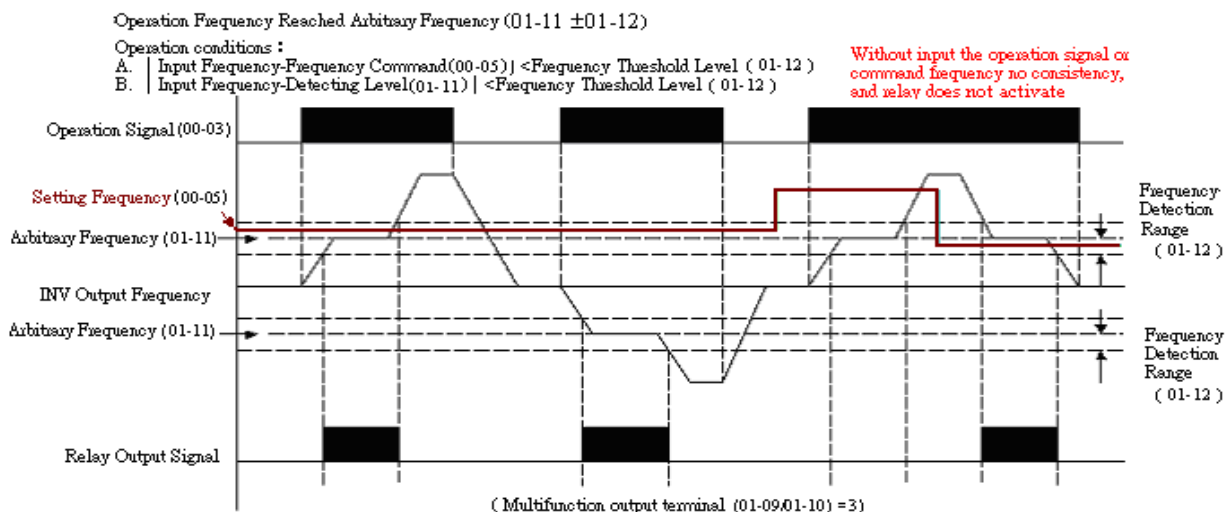

Figure 4-7 Frequency within specified range example

01-09/10= 4: Frequency detection $F_{out} > 01-11$

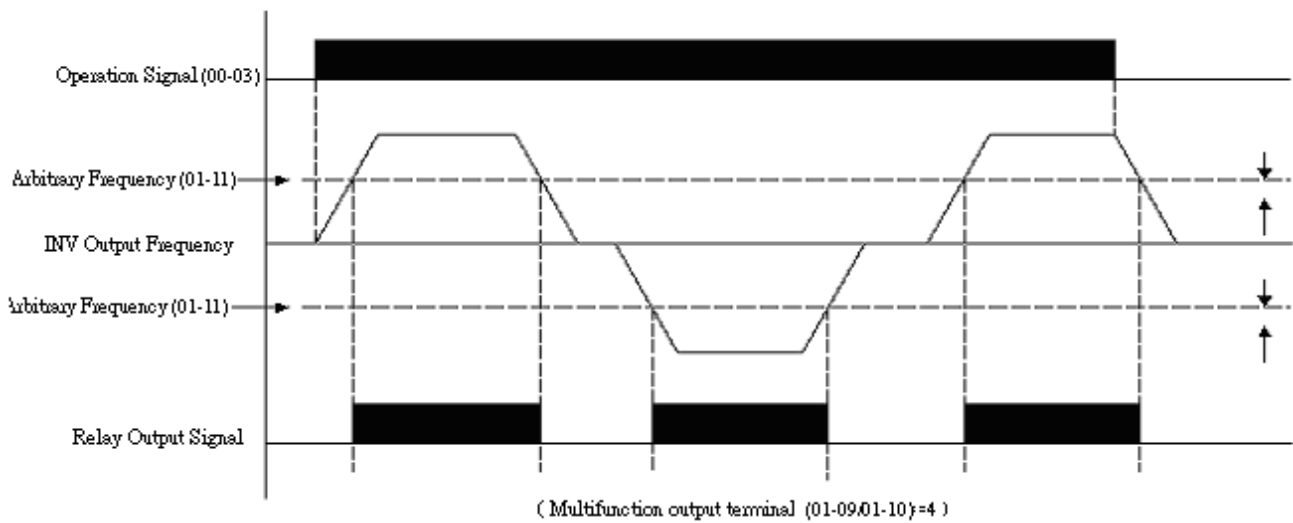

Figure 4-8 Frequency outside of range example

01-09/10= 5: Frequency detection $F_{out} < 01-11$

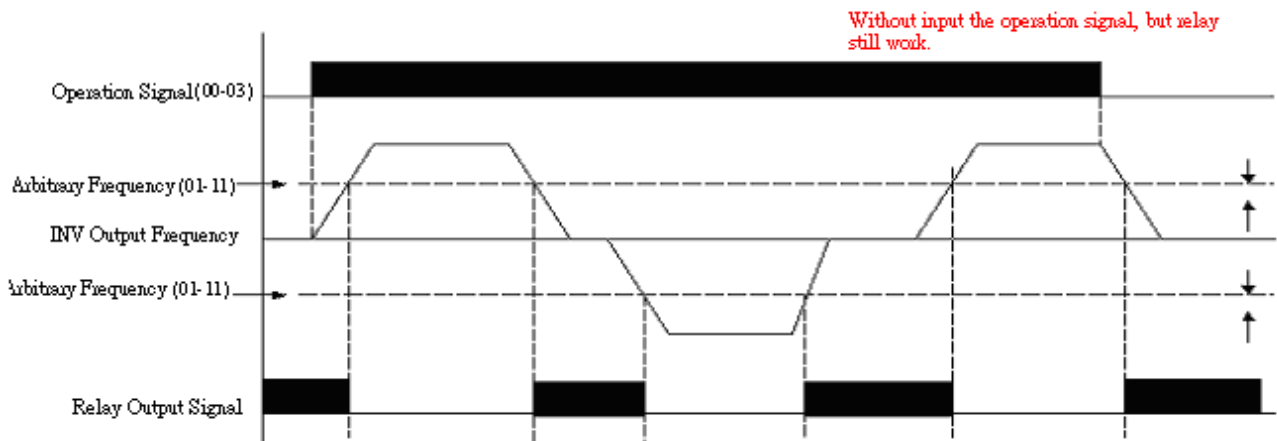

Figure 4-9 Frequency at or below specified range example

01-13: s1~s5 switch type select

=xxxx0:	S1	NO	=xxxx1:	NC
=xxx0x:	S2	NO	=xxx1x:	NC
=xx0xx:	S3	NO	=xx1xx:	NC
=x0xxx:	S4	NO	=x1xxx:	NC
=0xxxx:	S5	NO	=1xxxx:	NC

※Note: “NO”: Normal open, “NC”: Normal close.

The switches type is decided by 01-13,

Because of different types of switches, select switches type is necessary.

If set 01-13=0 0 0 0, means S1~S5 types of switches is Normal open, otherwise, if each bit of 01-13 is set to “1”, types of switches is Normal close.

Don't set 00-03/00-04=1 , before you set 01-13,(external terminal controlled)

Group2- External terminal analog signal input function group

02-00: AIN analog Input signal type select
 =0: 0 ~ 10V =1: 4 ~ 20mA

02-00 : AIN analog Input signal type select (refer to P3-12)

1. 0~10V $F(\text{hz}) = \frac{V(v)}{10(v)} \times (00-07)$, SW1=V, Input voltage

2. 4~20mA $F(\text{hz}) = \frac{I-4(\text{mA})}{20-4(\text{mA})} \times (00-07)$, I >= 4, SW2=I, Input current, or F = 0, I < 4

02-01: AIN signal verification Scan Time =1 ~ 200
02-02: AIN Gain(%) =0 ~ 200
02-03: AIN Bias(%) =0 ~ 100
02-04: AIN Bias Selection =0:positive =1:Negative
02-05: AIN Slope =0:positive =1:Negative

The setting of figure 4-18A:

	2-02	2-03	2-04	2-05
A	100%	50%	0	0
B	100%	0%	0	0

The setting of figure 4-18B:

	2-02	2-03	2-04	2-05
C	100%	50%	0	1
D	100%	0%	0	1

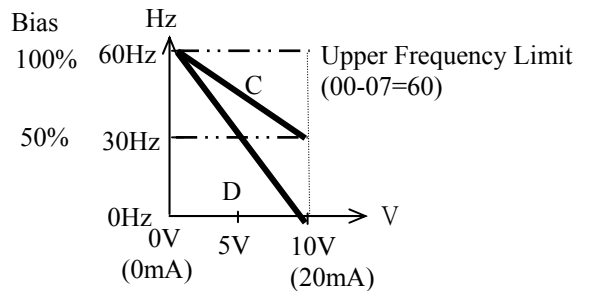
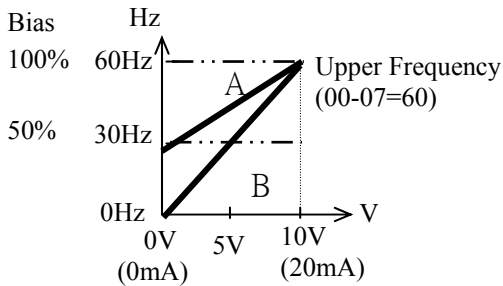

The setting of figure 4-18C:

	2-02	2-03	2-04	2-05
E	100%	20%	1	0

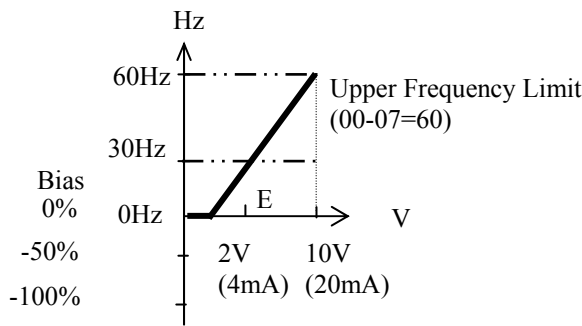

The setting of figure 4-18D:

	2-02	2-03	2-04	2-05
F	100%	50%	1	1

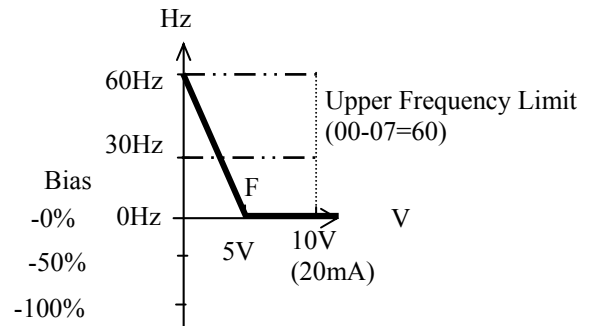

Figure 4-10 Analog scaling examples

- 1) The inverter reads the average value of A/D signals once per (02-01/02-07 x 2mS). Set scan intervals according to possible noise interference in the environment. Increase 02-01/02-07 in an environment with noise interference, but the response time will increase accordingly.

Multifunction analog output control

02-12: Analog Output Voltage Mode

- =0: Output frequency
- =1: Frequency Setting
- =2: Output voltage
- =3: DC Bus Voltage

02-13: FM+ Gain(%) =0 ~ 200

Note: the max output voltage is 10V due to hardware of the circuit. Use only devices that require a maximum of 10V signal.

Group3- preset Frequency function group

03-00: Preset Speed Control mode Selection

- =0: common Is uniform time(Acc/Dec)
- =1: Special (is single time Acc0/Dec0 ~ Acc7/Dec7)

Setting frequency 03-01~03-08 :

Preset Speed 0 ~ Preset Speed 7 (Hz) : =0.00 ~ 400.00

Setting time 03-17~03-32 :

Preset Speed 0~7 Acceleration time(second): =0.1 ~ 3600.0

Preset Speed 0~7 Deceleration time(second): =0.1 ~ 3600.0

1. When 03-00 is set to 0, Acc-time (Dec-time) is determined by the 00-09/00-10.
2. When 03-00 is set to 1, Acc-time(Dec-time) is determined by the 03-17~03-32.

Function Description:

- 1) Formula for calculating acceleration and deceleration time: The denominator is base on the rated frequency of motor (05-04).

$$\text{Actual Acctime} = \frac{\text{Acctime parameter} \times \text{preset frequency}}{05-04}$$

$$\text{Actual Dectime} = \frac{\text{Dectime parameter} \times \text{pr eset frequency}}{05-04}$$

Example: 05-04 = 50 Hz (Maximum Frequency), 03-02 = 10 Hz (preset speed),
 03-19=5s (Acc time) ,03-04=20s(Dec time) ,

$$\text{Preset speed 1 Actual Acc time} = \frac{03-19 \times 10(\text{hz})}{05-04} = 1(\text{s})$$

$$\text{Preset speed 1 Actual Dec time} = \frac{03-20 \times 10(\text{hz})}{05-04} = 4(\text{s})$$

2) When 03-00 is set to 1, the time has two modes to be set:

Example: 00-03=1,01-00=0 (S1=RUN/STOP) ,

01-01=1 (S2=forward/reserve),

01-02=2 (S3=preset speed1), 01-03=3 (S4= preset speed 2),

01-03=4 (S5= preset speed 4);

mode1: When the run command is uncontinuous, calculate acceleration and deceleration time of each segment like this

$$a = \frac{(03-17) \times (03-01)}{05-04}, b = \frac{(03-18) \times (03-01)}{05-04}, c = \frac{(03-19) \times (03-02)}{05-04}, d = \frac{(03-20) \times (03-02)}{05-04} \dots\dots$$

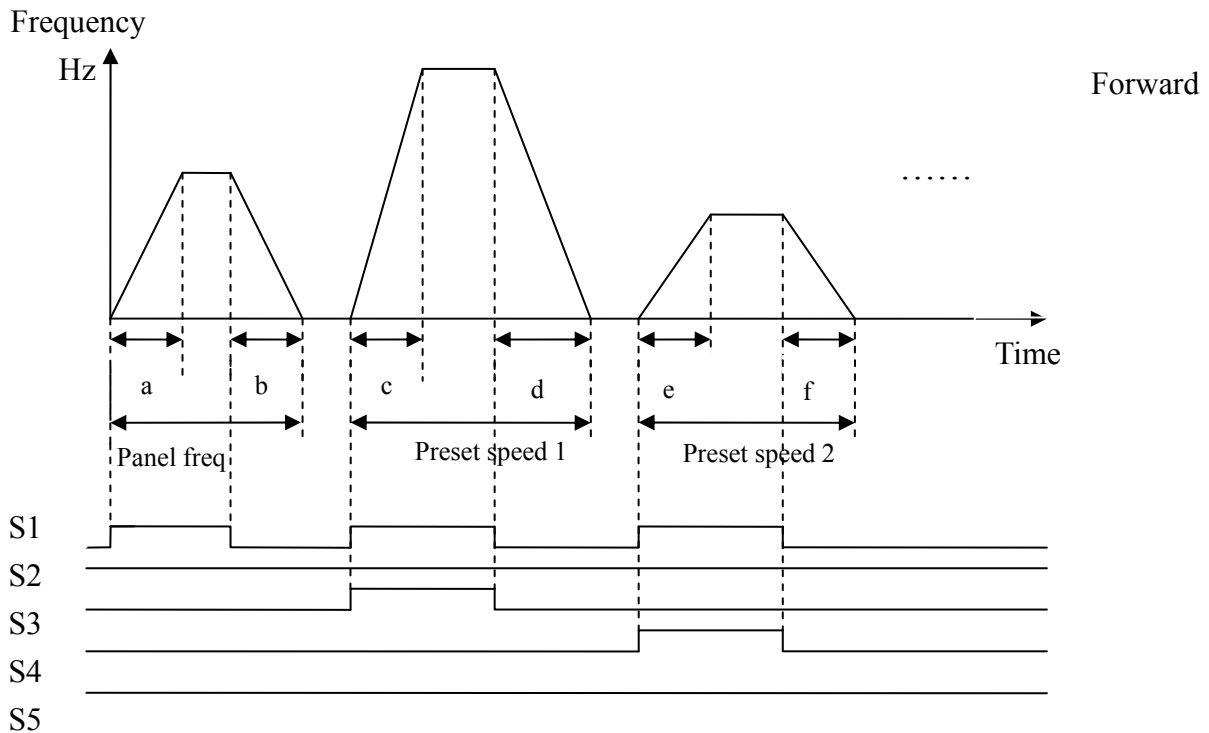

mode2: When the run command is continuous , calculate acceleration and deceleration time of each segment like this

$$a = \frac{(03-17) \times (03-01)}{05-04}, b = \frac{(03-20) \times [(03-01) - (03-02)]}{05-04}, c = \frac{(03-21) \times [(03-03) - (03-02)]}{05-04}$$

$$d = \frac{(03-24) \times (03-03)}{05-04}, e = \frac{(03-23) \times (03-04)}{05-04}, f = \frac{(03-26) \times (03-04)}{05-04}, g = \frac{(03-25) \times (03-05)}{05-04},$$

$$h = \frac{(03-26) \times (03-05)}{05-04} \dots\dots$$

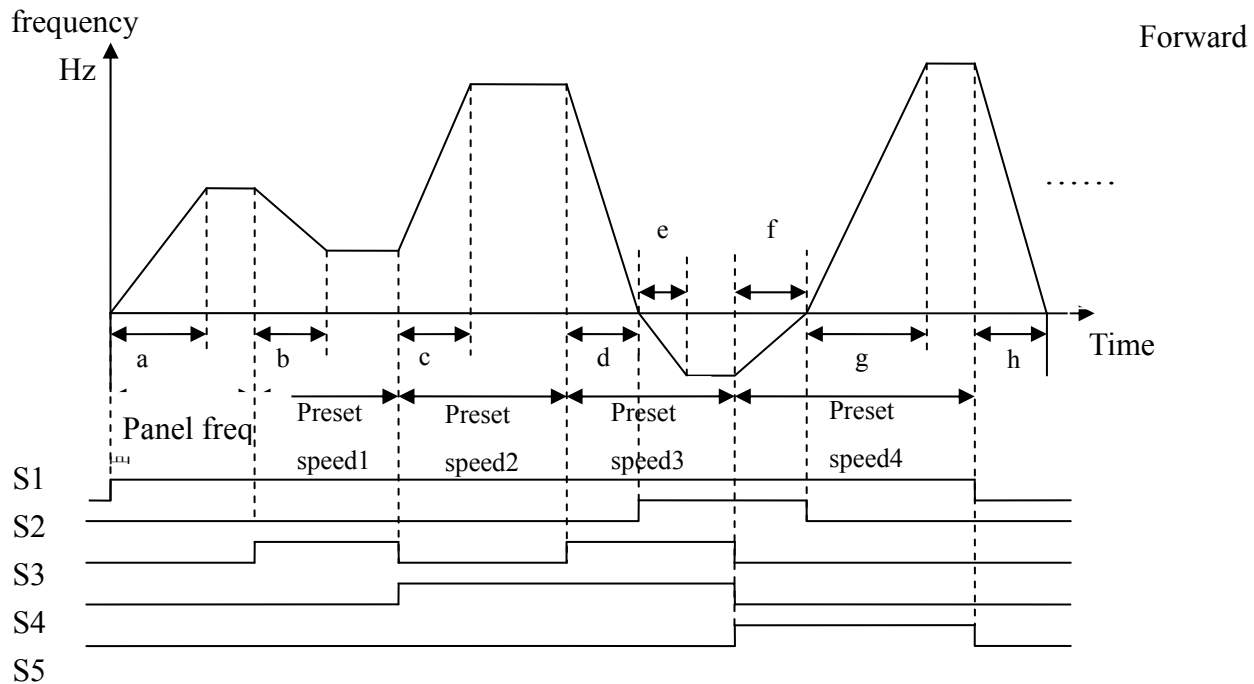

Group4- Start/Stop command group

04-01 : Stopping Method Selection =0: Enhanced braking capacity
=1: Coast to stop

- 04-01=0: the inverter will decelerate to 0Hz in preset deceleration time after receiving the stop command. (Normal stop)
- 04-01=1: the inverter will stop output as receiving the stop command. The motor will inertia Coast to stop.

04-03 : Momentary power loss and restart
=0: Momentary Power Loss and Restart disable
=1: Momentary power loss and restart enable while CPU is operating. (According to the capacity of DC power)

- If the input power supply due to sudden increase in supply demand by other equipment results in voltage drops below the under voltage level, the inverter will stop output at once. If the power supply voltage level recovers in the preset time, it will spin start tracing from the trip frequency, or otherwise the inverter will trip with ‘LV-C’ fault displayed.
- The allowable power loss time differs with the models. The range is from 1second to 2 second.
- 04-03=0: as power lost, the inverter will not start.

04-08: Reset Mode Setting =0: Enable Reset Only when Run Command is Off
=1: Enable Reset when Run Command is On or Off

04-08=0 Once the inverter is detected a fault, please turn Run switch Off and then On again to perform reset, otherwise restarting will not be possible.

04-09: Direct Running After Power Up
=0: Enable Direct running after power up
=1: Disable Direct running after power up

! Danger:

1. 04-09=0 and the inverter is set external terminal controlled (00-03=1), if the run switch is ON as power is supplied, the inverter will auto start. It is recommend that the power is turned off and the run switch is also off to avoid possibility of injury to operators and machines as the power is reapplied.

Note: IF this mode is required all safety measures must be considered including warning labels.

2. 04-09=1 and the inverter is set external terminal controlled (00-03=1), if the run switch is ON as power is supplied, the inverter will not auto start and the display will flash with STP1.

It is necessary to turn OFF the run switch and then ON to start normally.

04-15: DC Injection Brake Start Frequency (Hz) @Stopped = 0.10 ~ 10.00

04-16: DC Injection Brake Level (%)@Stopped = 0.0 ~ 150.0

04-17: DC Injection Brake Time (Seconds)@stopped = 0.0 ~ 25.5

1. 04-17 / 04-15 is the action time and start frequency of DC braking, as graph below:

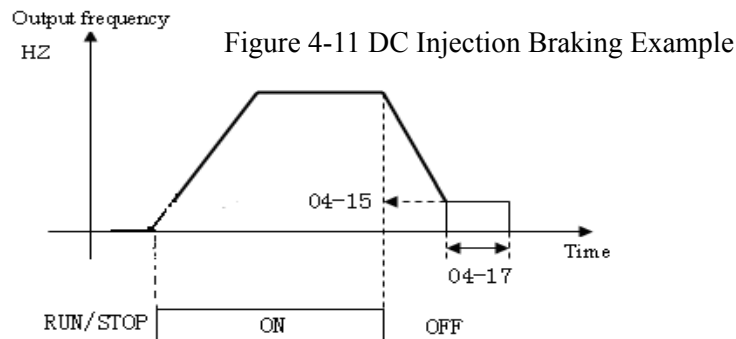

04-18 :DC Injection Brake@ Running = 0: DC Injection Brake @running enable

= 1: DC Injection Brake @running disable

04-18=0, DC Injection Brake @running disable; 04-18=1, if run command remains, and frequency command was decreased to 0, DC break while running keep working.

Group5- V/F command group

V/F PATTERN Selection

05-00: Volts/Hz Curve Modification (Torque Boost) (%) =0 ~ 30.0

05-02: Motor rated Slip Compensation (%) = 0.0 ~100.0

05-03: v/f Maximum voltage (Vac) = 198.0 ~ 256.0

05-04: Maximum Frequency (Hz) = 0.20 ~ 400.0Hz

05-05: Maximum Frequency Voltage Ratio (%) = 0.0 ~ 100.0

05-06: Medium Frequency2 (Hz) = 0.10 ~ 400.0Hz

05-07: Medium Frequency Voltage Ratio2(%) = 0.0 ~ 100.0

05-08: Medium Frequency1 (Hz) = 0.10 ~ 400.0Hz

05-09: Medium Frequency Voltage Ratio1 (%) = 0.0 ~ 100.0

05-10: Minimum Frequency (Hz) = 0.10 ~ 400.0Hz

05-11: Minimum Frequency Voltage Ratio (%) = 0.0 ~ 100.0

1.00-01=7, set the V/F pattern freely complying with 05-04 ~ 05-09 (Refer to following diagram)

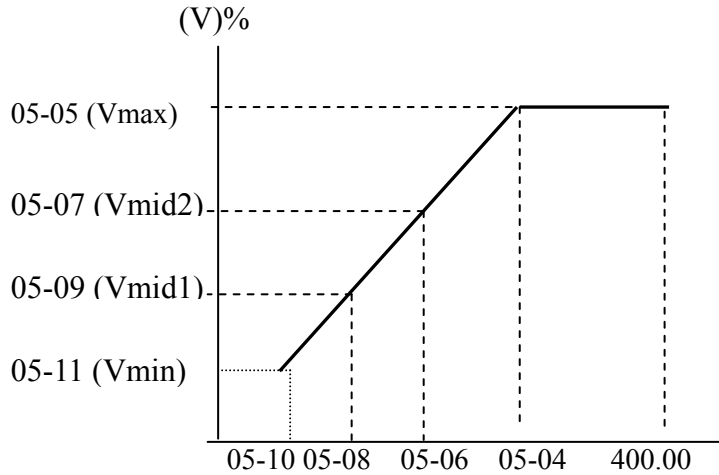

Figure 4-12 Custom V/F Settings

2. 00-01 = 1 ~ 6 V / F Pattern (Refer to following list)

type	Function	00-01	V/F pattern	type	Function	00-01	V/F pattern
50 Hz	General Use	1		60 Hz	General Use	4	
	High start torque	2			High start torque	5	
	Decreasing torque	3			Decreasing torque	6	

3. The inverter will output the value of B, C voltage (refer to 00-01) plus the 05-00 V/F pattern setting. The starting torque will be raised as shown.

00-01	B	C
1/4	10%	8%
2/5	15%	10.5%
3/6	25%	7.7%

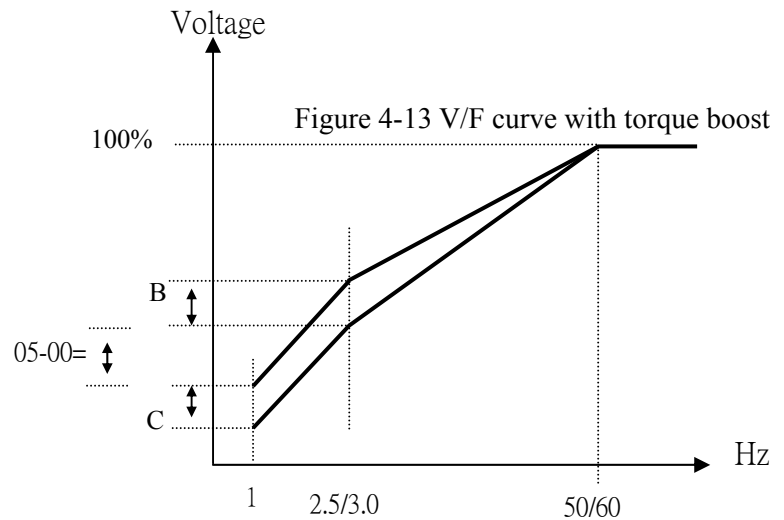

※Note: 05-00=0, Torque boost function is invalid

Group7- Protection function group

07-00: Trip Prevention Selection

- = xxxx0: Enable Trip Prevention During Acceleration
- = xxxx1: Disable Trip Prevention During Acceleration
- = xxx0x: Enable Trip Prevention During Deceleration
- = xxx1x: Disable Trip Prevention During Deceleration
- = xx0xx: Enable Trip Prevention in Run Mode
- = xx1xx: Disable Trip Prevention in Run Mode
- = x0xxx: Enable over voltage Prevention in Run Mode
- = x1xxx: Disable over voltage Prevention in Run Mode

07-01: Trip Prevention Level During Acceleration (%)	=50 ~ 200
07-02: Trip Prevention Level During Deceleration (%)	= 50 ~ 200
07-03: Trip Prevention Level In Run Mode (%)	=50 ~ 200
07-04: Over voltage Prevention Level in Run Mode	=80 VDC ~ 100 VDC

Note:

1. In acceleration, the inverter will delay the acceleration time if the time is too short resulting in the over current in order to prevent the inverter trips.
2. In deceleration, the inverter will delay the acceleration time if the time is too short resulting in the over voltage of DC VUS in order to prevent the inverter trips with 'OV' displayed.
3. Some mechanical characteristics (such as press) or unusual breakdown (seize due to insufficient lubrication, uneven operation, impurities of processed materials, etc.) will cause the inverter to trip, thus inconvenience users. When the operating torque of the inverter exceeds the setting of 07-03, the inverter will lower the output frequency following the deceleration time and return to the normal operation frequency after the torque get steady.

07-05: Electronic Motor Overload Protection Operation Mode:

- =0: Enable Electronic Motor Overload Protection
- =1: Disable Electronic Motor Overload Protection

07-06: Motor Rated Current (Amp AC)

07-13: OH over heat Protection (cooling fan control)

=0: 0: Auto (Depends on temp.)

=1: Operate while in RUN mode

=2: Always Run

=3: Disabled

1. 07-13=0: The fan runs as the inverter senses temperature rises. Thusly, extend the service period.
2. 07-13=1: The fan runs while the inverter is running.
3. 07-13=2: The fan is continuously running regardless of the action of the inverter.
4. 07-13=3: The fan is **Disabled**.

Group8- Communication function group

08-00: Assigned Communication Station Number = 1 ~ 32

08-00: to set the communication station codes which are suitable for driving more than one inverters situations.

08-02: Baud Rate Setting (bps)

= 0 : 4800

= 1: 9600

= 2: 19200

= 3: 38400

08-03: Stop Bit Selection = 0: 1 stop bit

= 1: 2 stop bits

08-04: Parity Selection =0 : no parity

=1 : even parity

=2 : odd parity

08-05: Data Format Selection =0 : 8 bit data

=1 : 7 bit data

1. RS-485 Communication:

- 1) One to one communication: A controller, PC or PLC, controls one inverter. (Set 08-00 = 1~32)
- 2) One to many communication: A controller, PC or PLC, controls multiple inverters (Up to 32 Inverters as max. Set 08-00 = 1~32). When any inverter receive the communication station number 0, from the PC or PLC (Broadcast mode) then all these inverters will be controlled in communication mode regardless of the setting of parameter 08-00.

Note: Note:

- a. The BAUD RATE of PC (or PLC or Controller) and the one of the inverter should be set as the same .Communication format (08-02/08-03/08-04) should be set as the same.
- b. The inverter will confirm the parameter efficient as PC modifies the parameter of the inverter.
- c. Please refer to the S310 Communication PROTOCOL.

08-06:Communication time-out operation selection (second) = 0.0 ~ 25.5

08-07: Communication time-out detection time

1) Time-out detection time: 00.0~25.5sec; setting 00.0 sec: disable time-out function.

2) Time-out operation selection:

0: Deceleration to stop and display" COT"

1: Free run to stop and display" COT"

2: Continue operating and display" COT"

***Cannot be modified during communication.**

08-08 :Err6 fault tolerance times = 1 ~ 20

When communication error times \geq 08-08 setting, display ERR6 on the keypad.

Group10- Assistant function group

10-01: Prevention of Reverse operation

=0: Reverse command is enabled

=1: Reverse command is disabled

10-01=1, the reverse command is **disabled**.

10-03: Carrier Frequency (KHz) =1 ~ 12

10-03	Carrier Frequency	10-03	Carrier Frequency	10-03	Carrier Frequency		
1	1KHz	5	5KHz	9	9KHz		
2	2KHz	6	6KHz	10	10KHz		
3	3KHz	7	7KHz	11	11KHz		
4	4KHz	8	8KHz	12	12KHz		

Note : The external electronic components maybe interfered, more serious, even the motor vibration due to cutting of the high carrier frequency waveform, although the inverter provides low noise environment in running. Thusly, it is necessary to regulate the carrier frequency.

10-04: Carrier mode selection =0 Carrier mode0

=1 Carrier mode1 =2 Carrier mode2

1. 10-04=0: Carrier mode0 is recommended in environments where low noise is required, correct ambient temperature and cooling is necessary.

2. 10-04=1: Carrier mode1 is locale of wind power and waterpower

3. 10-04=2: Carrier mode2 is modulation for two-phase

10-16 : AVR Control = 0: AVR function effective = 1: AVR function ineffective

That Automatic Voltage Regulator(AVR) will determine the actual output voltage when(00-01) is set to 7.

Group11-keypad display group

11-00 : Display Mode

=xxxx0: Disable Motor Current Display	=xxxx1: Enable Motor Current Display
=xxx0x: Disable Motor Voltage Display	=xxx1x: Enable Motor Voltage Display
=xx0xx: Disable Bus Voltage Display	=xx1xx: Enable Bus Voltage Display
=x0xxx: Disable temperature Display	=x1xxx: Enable temperature Display

11-01: Custom Units (Line Speed) Value 0 ~ 65535

The max preset line value of 11-01 is equal to the rated frequency (06-04) of the motor. For instance, given line speed 1800 is equal to display 900 when output is 30Hz while the operation frequency is 60Hz.

11-02: Custom Units (Line Speed) Display Mode

=0: Drive Output Frequency is Displayed
=1: Line Speed is Displayed in Integer (xxxxx)
=2: Line Speed is Displayed with One Decimal Place (xxxx.x)
=3: Line Speed is Displayed with Two Decimal Places (xxx.xx)
=4: Line Speed is Displayed with Three Decimal Places (xx.xxx)

When 11-02=1/2/3/4 , line speed is displayed while the inverter is running or stopped.

Group12- User parameter group

12-00: Drive Horsepower Code

Only read

12-01: Software Version

Note: Read only

12-02: Fault Log (Latest 3 times)

1. When the inverter trips on a fault, the previous fault log stored in 2.xxx will be transferred to 3.xxx, the one in 1.xxx to 2.xxx. The present fault will be stored in the empty register 1.xxx. The fault stored in 3.xxx is the last one of the most recent three, while the one 1.xxx is the latest.
2. When pressing 'ENTER' at 12-02, the fault 1.xxx will be displayed first. Press ▲, to read 2.xxx→3.xxx→1.xxx press ▼ and the order is 3.xxx→2.xxx→1.xxx→3.xxx.
3. When pressing 'Reset' at 12-02, the three fault log will be cleared when the reset key is pressed. The log content will change to 1.--, 2.--, 3.--.
4. E.g. the fault log content is '1.OC-C'; this indicates the latest fault is OC-C, etc.

12-06: Reset Drive to Factory Settings	=1150: Reset to the 50Hz factory setting
	=1160: Reset to the 60Hz factory setting

12-07 : Parameter lock	=0: Enable all Functions
	=1: 03-01~ 03-08 cannot be changed
	=2: All Functions cannot be changed Except 03-01~ 03-08
	=3: Disable All Function

Group13- Auto Run (Auto Sequencer) function group

Auto Run(sequencer) mode selection:

13-00: 0: Disabled.

=1: Single cycle. (Continues to run from the unfinished step if restarted).

=2: Periodic cycle. (Continues to run from the unfinished step if restarted).

=3: Single cycle, then holds the speed of final step to run.

(Continues to run from the unfinished step if restarted).

=4: Single cycle. (Starts a new cycle if restarted).

=5: Periodic cycle. (Starts a new cycle if restarted).

=6: Single cycle, then hold the speed of final step to run.

(Starts a new cycle if restarted).

13-01 : Auto _ Run Mode Frequency Command 1 =0 ~ 400Hz

13-02 : Auto _ Run Mode Frequency Command 2 =0 ~ 400Hz

13-03 : Auto _ Run Mode Frequency Command 3 =0 ~ 400Hz

13-04 : Auto _ Run Mode Frequency Command 4 =0 ~ 400Hz

13-05 : Auto _ Run Mode Frequency Command 5 =0 ~ 400Hz

13-06 : Auto _ Run Mode Frequency Command 6 =0 ~ 400Hz

13-07 : Auto _ Run Mode Frequency Command 7 =0 ~ 400Hz

13-16 : Auto_ Run Mode Running Time Setting 0 = 0 ~ 3600sec

13-17 : Auto_ Run Mode Running Time Setting 1 = 0 ~ 3600sec

13-18 : Auto_ Run Mode Running Time Setting 2 =0 ~ 3600sec

13-19 : Auto_ Run Mode Running Time Setting 3 =0 ~ 3600sec

13-20 : Auto_ Run Mode Running Time Setting 4 =0 ~ 3600sec

13-21 : Auto_ Run Mode Running Time Setting 5 =0 ~ 3600sec

13-22 : Auto_ Run Mode Running Time Setting 6 =0 ~ 3600sec

13-23: Auto_ Run Mode Running Time Setting 7 =0 ~ 3600sec

13-32: Auto_ Run Mode Running Direction 0 =0: STOP =1:forward =2:reverse

13-33: Auto_ Run Mode Running Direction 1 =0: STOP =1:forward =2:reverse

13-34: Auto_ Run Mode Running Direction 2 =0: STOP =1:forward =2:reverse

13-35: Auto_ Run Mode Running Direction 3 =0: STOP =1:forward =2:reverse

13-36: Auto_ Run Mode Running Direction 4 =0: STOP =1:forward =2:reverse

13-37: Auto_ Run Mode Running Direction 5 =0: STOP =1:forward =2:reverse

13-38: Auto_ Run Mode Running Direction 6 =0: STOP =1:forward =2:reverse

13-39: Auto_ Run Mode Running Direction 7 =0: STOP =1:forward =2:reverse

Note:

1. Auto Run (sequencer) various modes cab is selected by parameter 13-00.
2. Auto Run (sequencer) mode set up parameters are parameters (13-01 ~13-39).
3. Auto run mode (sequencer) operation as selected by parameter 13-00 can be set up as follows:-

- a. **Setting multi-step frequency commands**, by using the available multi-step frequency commands 0~7as required can be set by parameters (13-00 ~ 13-07).
- b. **Setting multi-step run time** ,by parameters (13-16 ~ 13-23) for each required step.
- c. FWD/REV direction can be selected by setting of parameters (13-32 ~13-39).
- d. Auto _ Run Mode Frequency Command 0 is 13-01, running time is 13-16, Running Direction 13-32.

Some examples in auto_run mode as follows:

(A) Single Cycle Running (13-00= 1, 4)

The inverter will run for a single full cycle based upon the specified setting mode. Then, it will stop.

- For example: 13-00=1 (or 4)
- Panel Frequency (3-01)=15 Hz 13-01=30Hz 13-02=50Hz 13-03=20Hz
 13-16=20s 13-17=25s 13-18=30s 13-19=40s
 13-32=1 13-33=1 13-34=1(FWD) 13-35=2(REV)
- 13-04 ~ 13-07=0Hz , 13-20 ~ 13-23=0s , 13-36 ~ 13-39=0

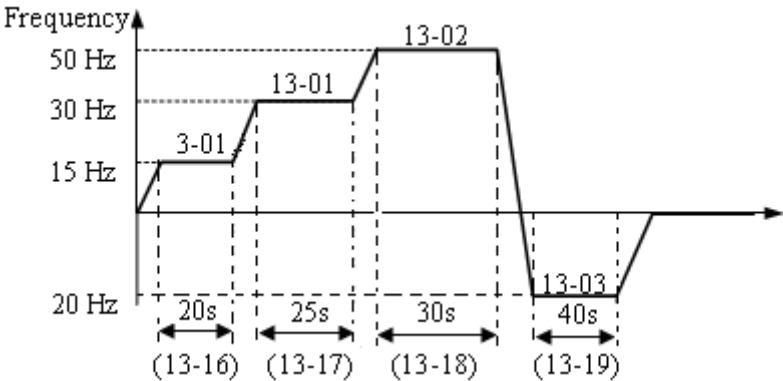

Figure 4-14 Single cycle auto run

(B) Periodic cycle Running (13-00=2, 5)

The inverter will repeat the same cycle periodically.

- For example: 13-00=2 (or 5)
- 13-01 ~ 13-03 , 13-16 ~ 13-23 , 13-32 ~ 13-39 : Same setting as the example (A)

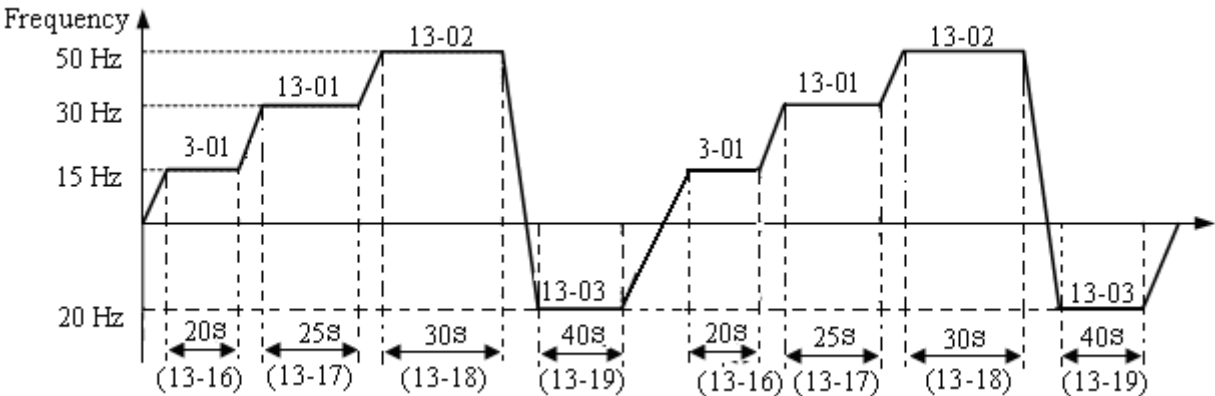

Figure 4-15 Periodic cycle auto run

(C) Auto_Run Mode for Single Cycle (13-00 = 3, 6)

The speed of final step will be held to run.

For example:

13-00 = 3 (or 6)

Panel Frequency (3-01) = 15 Hz 13-01=30Hz 13-02=50Hz 13-07=20Hz
 13-16=20s 13-17=25s 13-18=30s 13-23=40s
 13-32=1 13-33=1 13-34 = 1 13-39=1(FWD)
 13-04~13-06=0Hz , 13-20~13-22=0s , 13-35~13-38 = 0

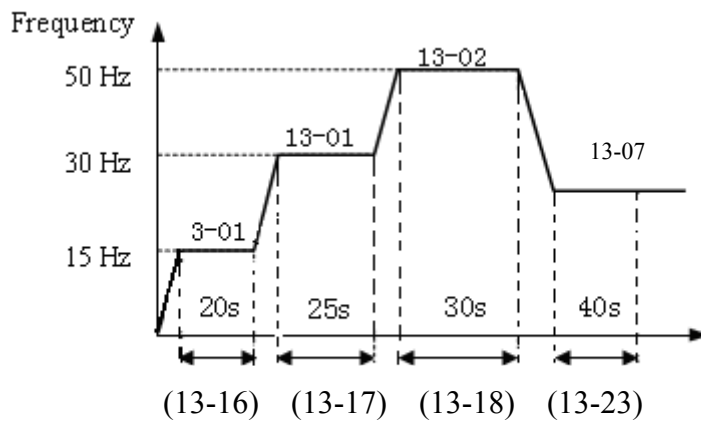

Figure 4-16 Single cycle auto run: final step hold

Note:13-00 = 1~3 : If the inverter stops and re-starts, it will continue running from the unfinished step, according to the setting of 13-00.

= 4~6: If the inverter stops and re-starts, it will begin a new cycle and continue running according to the setting of 13-00.

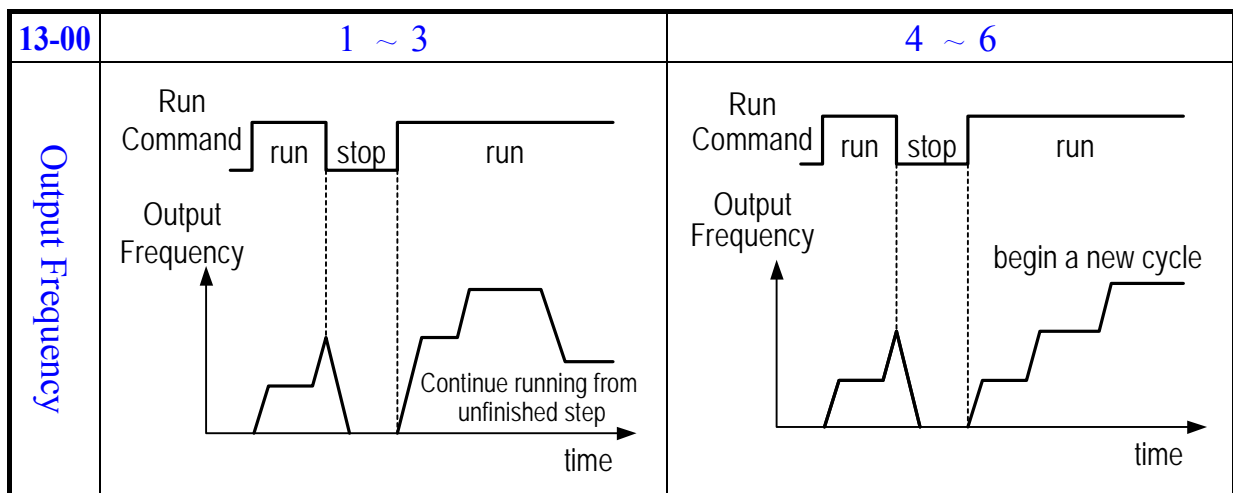

Figure 4-17 AUTO_RUN cycle with interrupt

- ACC/DEC time follow the setting of 00-09/00-10 or 10-05/10-06 in Auto Run Mode.

Chapter 5 Troubleshooting and maintenance

5.1. Error display and corrective action

5.1.1 Error display and corrective action

1. Faults which can not be recovered manually

Display	Fault	Cause	Corrective action
-OV-	Voltage too high when stopped	Detection circuit malfunction	Return the inverter
-LV-	Voltage too low when stopped	1. Power voltage too low 2. Pre-charge resistor or fuse burnt out. 3. Detection circuit malfunction	1. Check if the power voltage is correct 2. Replace the pre-charge resistor or the fuse 3. Return the inverter
-OH-	The inverter is overheated when stopped	1. Detection circuit malfunction 2. Ambient temperature too high or bad ventilation	1. Return the inverter 2. Improve ventilation conditions
CTER	Current Sensor detection error	Current sensor error or circuit malfunction	Return the inverter
EPR	EEPROM problem	Faulty EEPROM	Replace EEPROM
COT	Communication error	Communication error detect	(refer group 8)

2. Faults which can be recovered manually and automatically

Display	Fault	Cause	Corrective Action
OC-S	Over current at start	1.Short circuit between the motor coil and the case 2.Short circuit between motor coil and ground 3.the IGBT module damaged	1.Inspect the motor 2.Inspect the wiring 3.Replace the transistor module
OC-D	Over-current at deceleration	The preset deceleration time is too short.	Set a longer deceleration time
OC-A	Over-current at acceleration	1. Acceleration time too short 2. The capacity of the motor exceeds the capacity of the inverter 3. Short circuit between the motor coil and the case 4. Short circuit between motor wiring and ground 5. the IGBT module damaged	1. Set a longer acceleration time 2. Replace inverter with one that has the same rating as that of the motor 3. Check the motor 4. Check the wiring 5. Replace the IGBT module
OC-C	Over-current at fixed speed	1. Transient load change 2. Transient power change	1.Increase the capacity of the inverter
OV-C	Excessive Voltage during operation/ deceleration	1. Deceleration time setting too short or excessive load inertia 2. Power voltage varies widely (fluctuates)	1. Set a longer deceleration time 2. Add a brake resistor or brake module 3. Add a reactor at the power input side 4. Increase inverter capacity
OH-C	Heat sink temperature TooHigh during operation	1. Heavy load 2. Ambient temperature too high or bad ventilation	1. Check if there are any problems with the load 2. Increase inverter capacity 3. Improve ventilation conditions

3. Faults which can be recovered manually but not automatically

Display	Fault	Cause	Corrective Action
OC	Over-current during stop	1. Detection circuit malfunction 2. Bad connection for CT signal cable	1. Check the noise between Power line and motor line 2. Return the inverter for repair
OL1	Motor overload	1. Excessive load 2. Incorrect settings for 07-05	1. Increase the motor capacity 2. set 07-05 correctly
OL2	Inverter overload	Excessive Load	Increase the inverter capacity
LV-C	Voltage too low during operation	1. Power voltage too low 2. Power voltage varies widely (fluctuates)	1. Improve power quality or increase the value of 4-04 2. Set a longer acceleration time 3. Add a reactor at the power input side 4. Increase the motor capacity

5.1.2 Special conditions

Display	Fault	Description
STP0	Zero speed at stop	Occurs when preset frequency <0.1Hz
STP1	Fail to start directly On power up.	1. If the inverter is set for external terminal control mode (00-03=1) and direct start is disabled (04-09=1) The inverter cannot be started and will flash STP1. The run input is active at power-up; refer to descriptions of (04-09). 2. Direct start is possible when 04-09=0.
STP2	Keypad Stop Operated when inverter in external Control mode.	1. With the function of Stop key enabled by (04-01) And if the Stop key is pressed while the inverter is set to external control mode (00-03=1) then, the inverter will stop according to the setting of 04-01 and the error message, 'STP2' flashes after stop. Release and re-activate the run contact to restart the inverter. 2. If the inverter is in communication mode and the Stop key is enabled, the inverter will stop in the way set by 04-01 when Stop key is pressed during operation and then flashes STP2. The Host controller has to send a Stop command then a Run command to the inverter for it to be restarted.
E.S.	External Rapid stop	The inverter will decelerate to stop and then flash E.S., when input external Rapid stop signal via the multifunctional input terminal activates (refer to descriptions of 01-00~01-04).
b.b.	External base block	The inverter stops immediately and then flashes b.b., when external base block is input by the multifunctional input terminals. (Refer to descriptions of 01-00~01-04).

5.1.3 Operation errors

Display	Error	Cause	Corrective Action
Err1	Keypad operation error	1. Press ▲ or ▼ while 00-05>0 or running at preset speed. 2. Attempt to modify the Parameter. Can not be modified during operation (refer to the parameter list).	1.The ▲ or ▼ is available for modifying the parameter only when 00-05=0 2. Modify the parameter in STOP mode.
Err2	Parameter setting error	overrun the parameter limit	parameter reenactment
Err5	Modification of parameter is not available in communication	1. Control command sent during communication. 2. Attempt to modify the function 08-02 ~ 08-05 during communication	1. Issue enable command before communication 2. Set parameters 08-02 ~ 08-05 function before communication
Err6	Communication failed	1. Wiring error 2. Communication parameter setting error. 3. Check-Sum error	1. Check hardware and wiring 2. Check Functions 08-02 ~ 08-05
Err7	Parameter conflict	1. Attempt to modify the function 12-00/12-06. 2. Voltage and current detection circuit is abnormal	If Reset is not possible, please Return the inverter

5.1.4 The instructions for the Power and Alarm LED of the inverter:

1. When the inverter have mistakes which cannot be reseted, such as: CTER, EPR, OH, LV, OV, OC, the Alarm LED flashes quickly.

you can cut off the power of inverter, then turn it on again., if Alarm flashes the same as before, the inverter is faulted, please Return the inverter.

2. When the inverter have mistakes which can be reseted, such as:

OH-C, OV-C, OC-S, OC-d, OC-C, OC-a, OL2, OL1, the Alarm LED flashes slowly.

In order to release from the alarm, you can cut off the power of inverter, then turn it on again.

5.2 General troubleshooting

Status	Checking point	Remedy
Motor can not run	Is power applied to L1, L2, terminals (is the charging indicator lit)?	<ul style="list-style-type: none"> • Is the power applied? • Turn the power OFF and then ON again. • Make sure the power voltage is correct. • Make sure screws are secured firmly.
	Is there voltage across the output terminals U, V, and W?	<ul style="list-style-type: none"> • Turn the power OFF and then ON again.
	Is overload causing the motor to stall?	<ul style="list-style-type: none"> • Reduce the load so the motor will run.
	Are there any abnormalities in the inverter?	<ul style="list-style-type: none"> • See error descriptions to check wiring and correct if necessary.
	Is forward or reverse run command issued?	
	Has the analog frequency signal been input?	<ul style="list-style-type: none"> • Is analog frequency input signal wiring correct? • Is voltage of frequency input correct?
	Is the operation mode setting correct?	<ul style="list-style-type: none"> • Operate through the digital keypad .
Motor runs in wrong direction	Are wiring for output terminals U, V, and W correct?	<ul style="list-style-type: none"> • Wiring must match U, V, and W terminals of the motor.
	Are wiring for forward and reverse signals correct?	<ul style="list-style-type: none"> • Check for correct wiring.
The motor speed can not be regulated.	Is the wiring for the analog frequency inputs correct?	<ul style="list-style-type: none"> • Check for correct wiring.
	Is the setting of operation mode correct?	<ul style="list-style-type: none"> • Check the operation mode of the operator.
	Is the load too excessive?	<ul style="list-style-type: none"> • Reduce the load.
Motor running speed too high or too low	Check the motor specifications (poles, voltage...) correct?	<ul style="list-style-type: none"> • Confirm the motor specifications.
	Is the gear ratio correct?	<ul style="list-style-type: none"> • Confirm the gear ratio.
	Is the setting of the highest output frequency correct?	<ul style="list-style-type: none"> • Confirm the highest output frequency.
Motor speed varies unusually	Is the load too excessive?	<ul style="list-style-type: none"> • Reduce the load.
	Does the load vary excessively?	<ul style="list-style-type: none"> • Minimize the variation of the load. • Increase capacities of the inverter and the motor.
	Is the input power erratic or is a phase loss occurring?	<ul style="list-style-type: none"> • Add an AC reactor at the power input side if using single-phase power. • Check wiring if using three-phase power.

5.3 Quick troubleshooting of S310 series

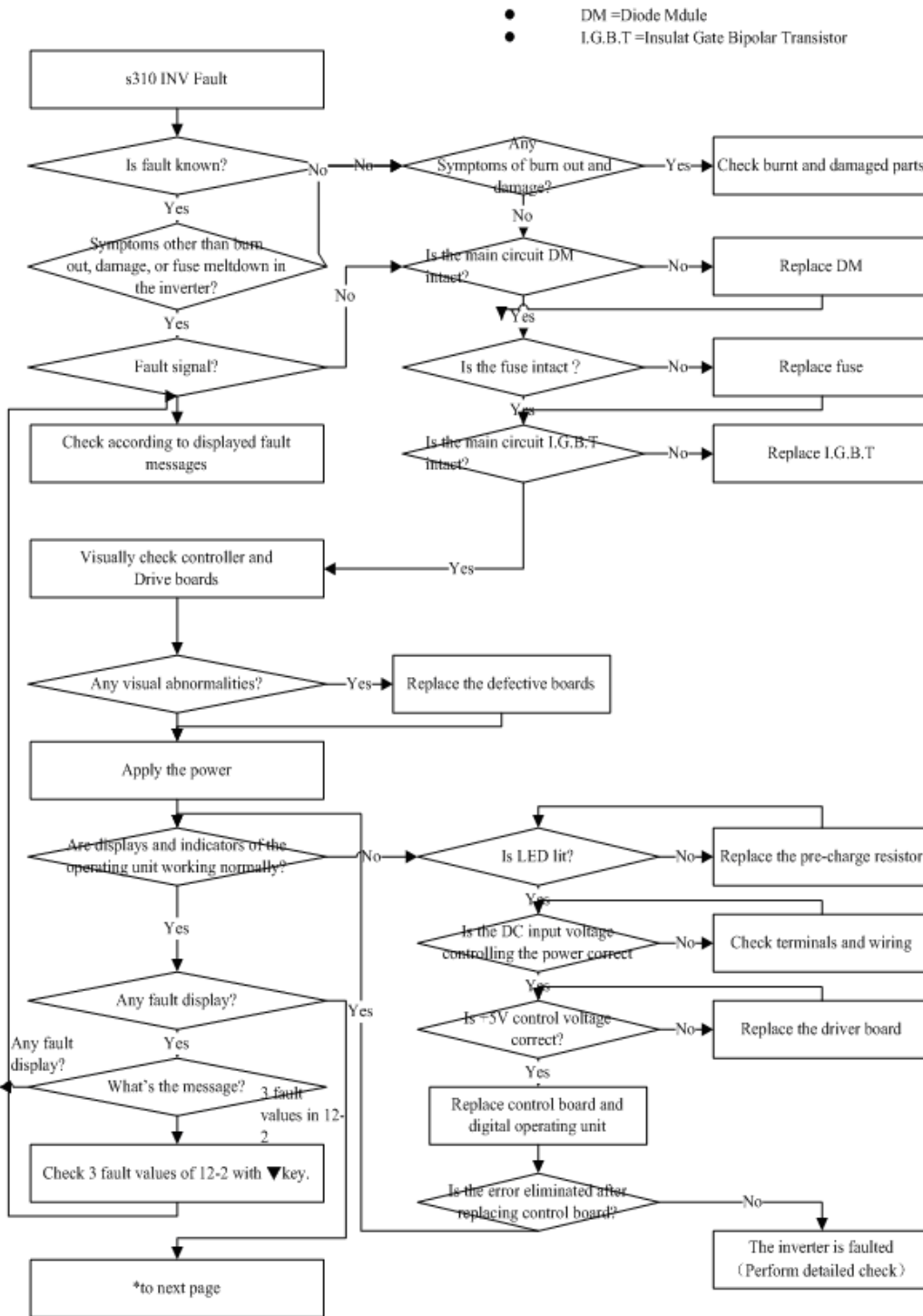

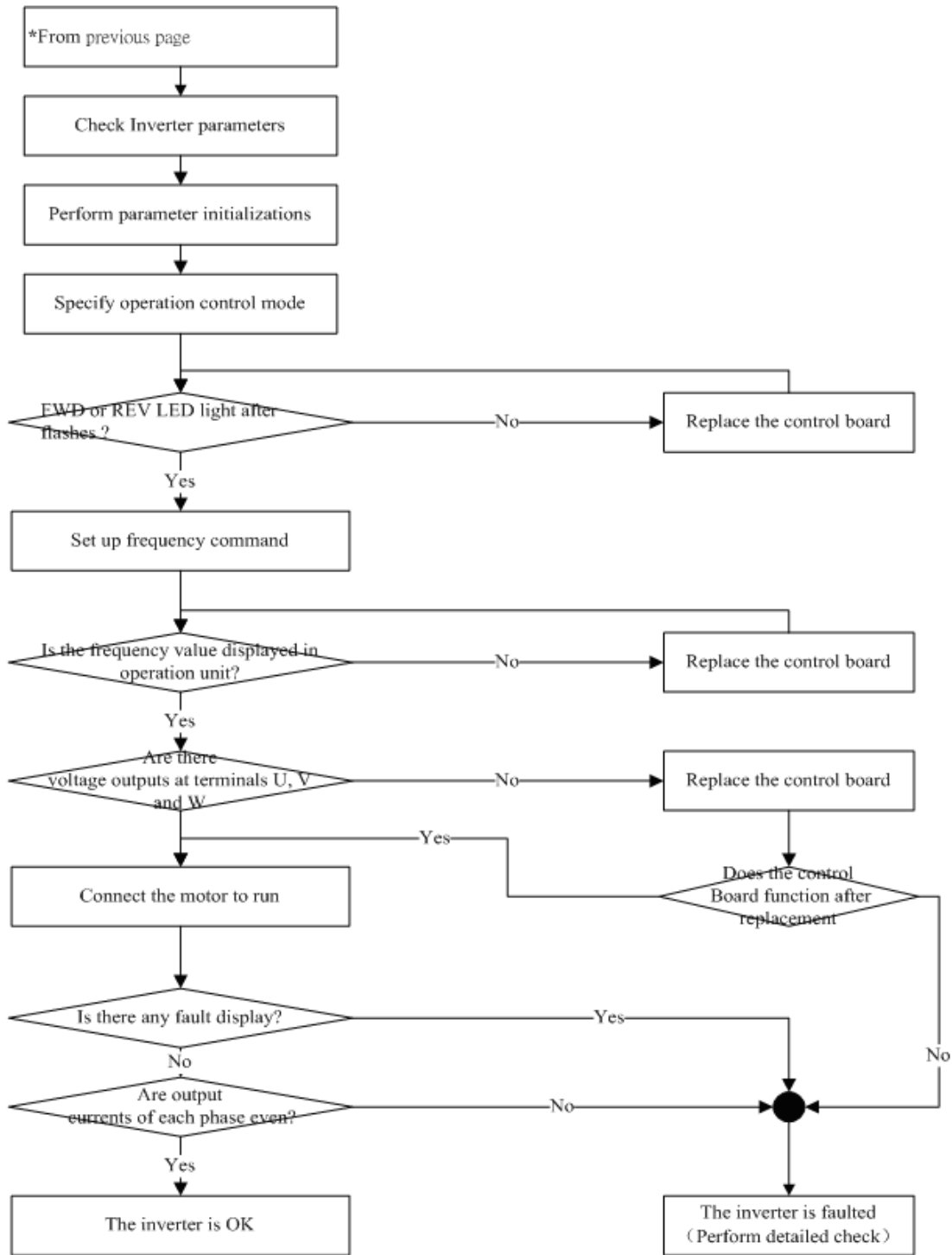

Figure 5-1 S310 fault display and troubleshooting flow chart

Troubleshooting for OC, OL error displays

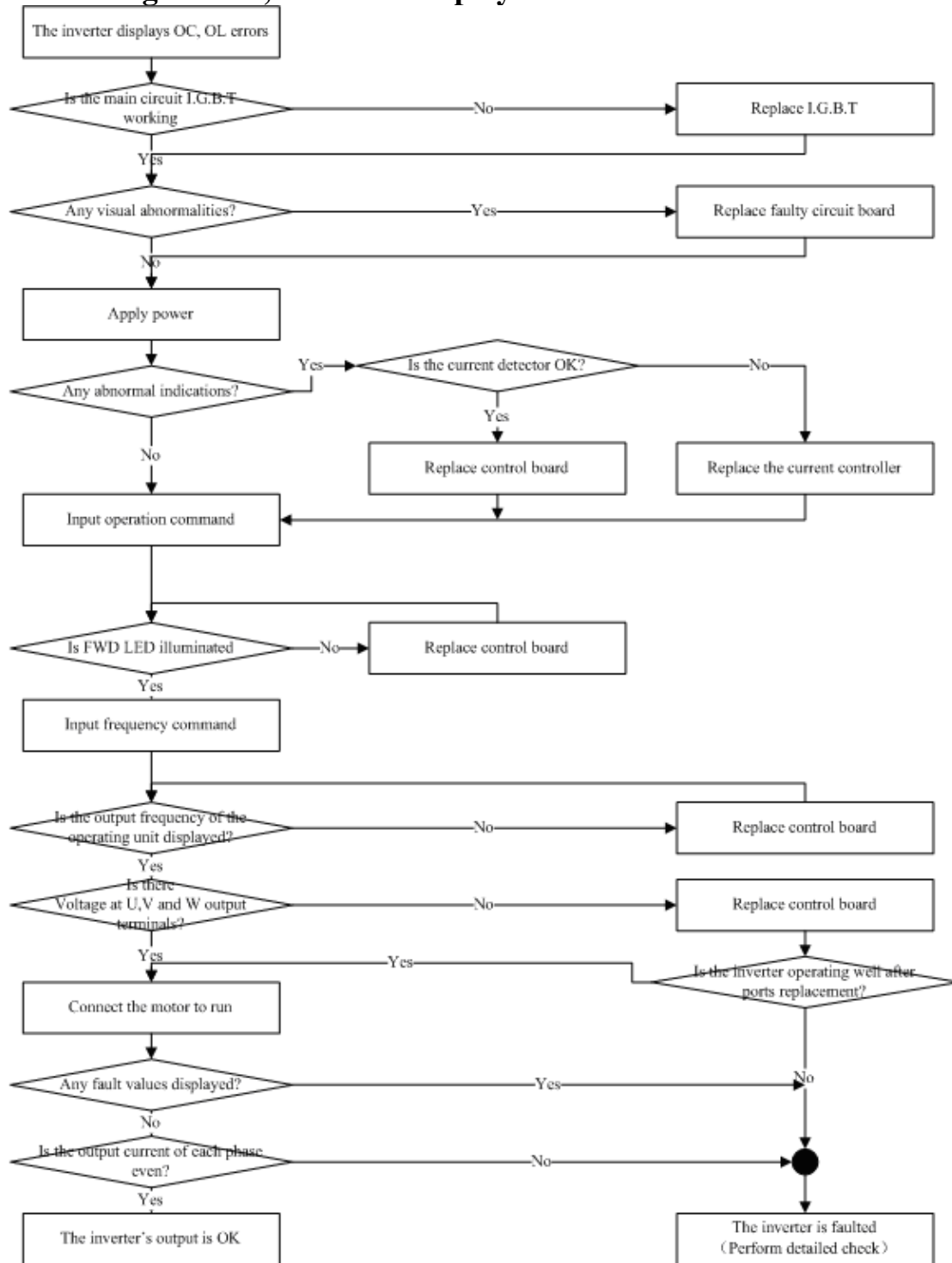

Figure 5-2 OC, OL Fault Display Flow Chart

Troubleshooting for OV, LV error

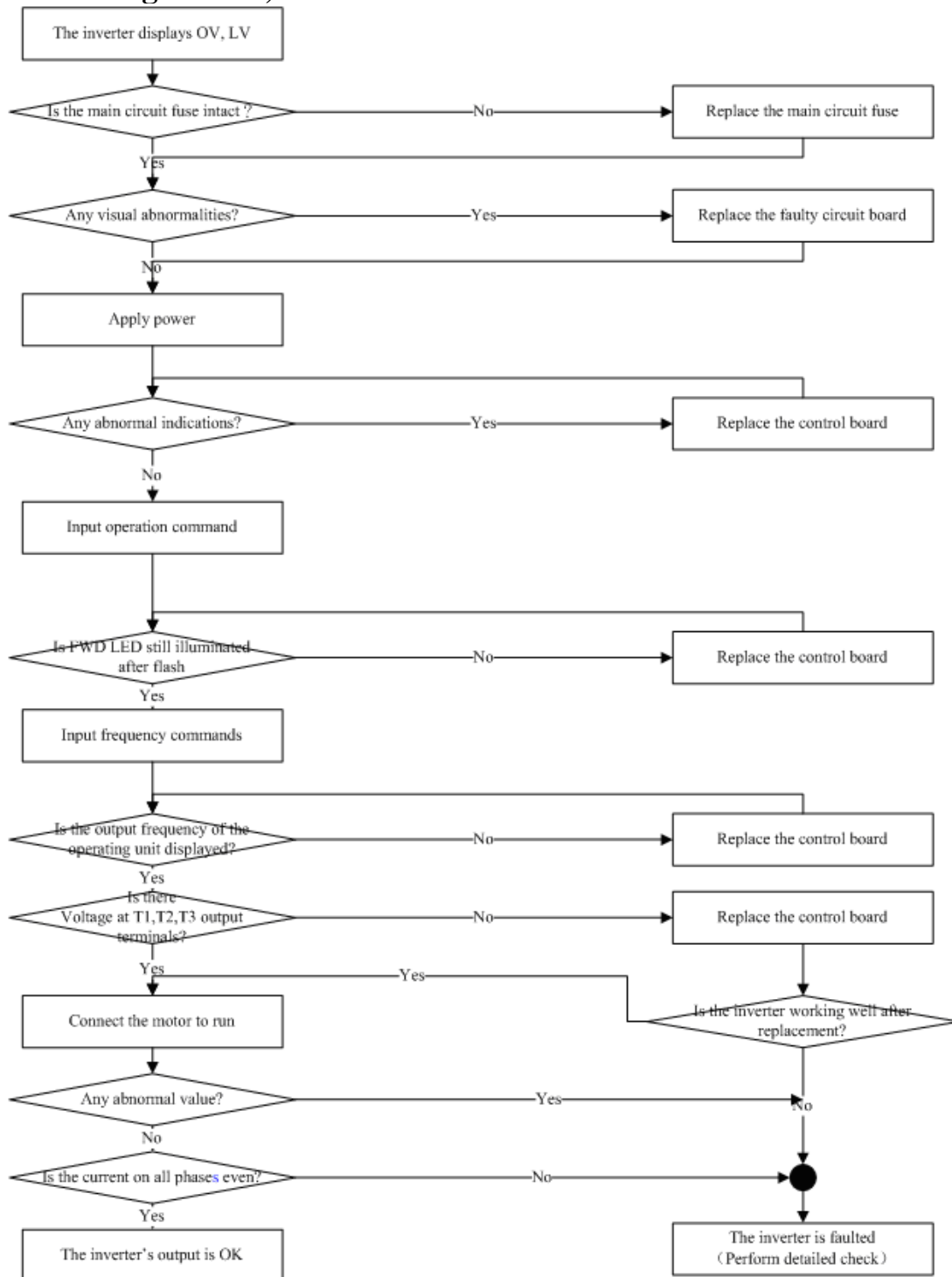

Figure 5-3 OV, LV Fault Display Flow Chart

The motor can not run

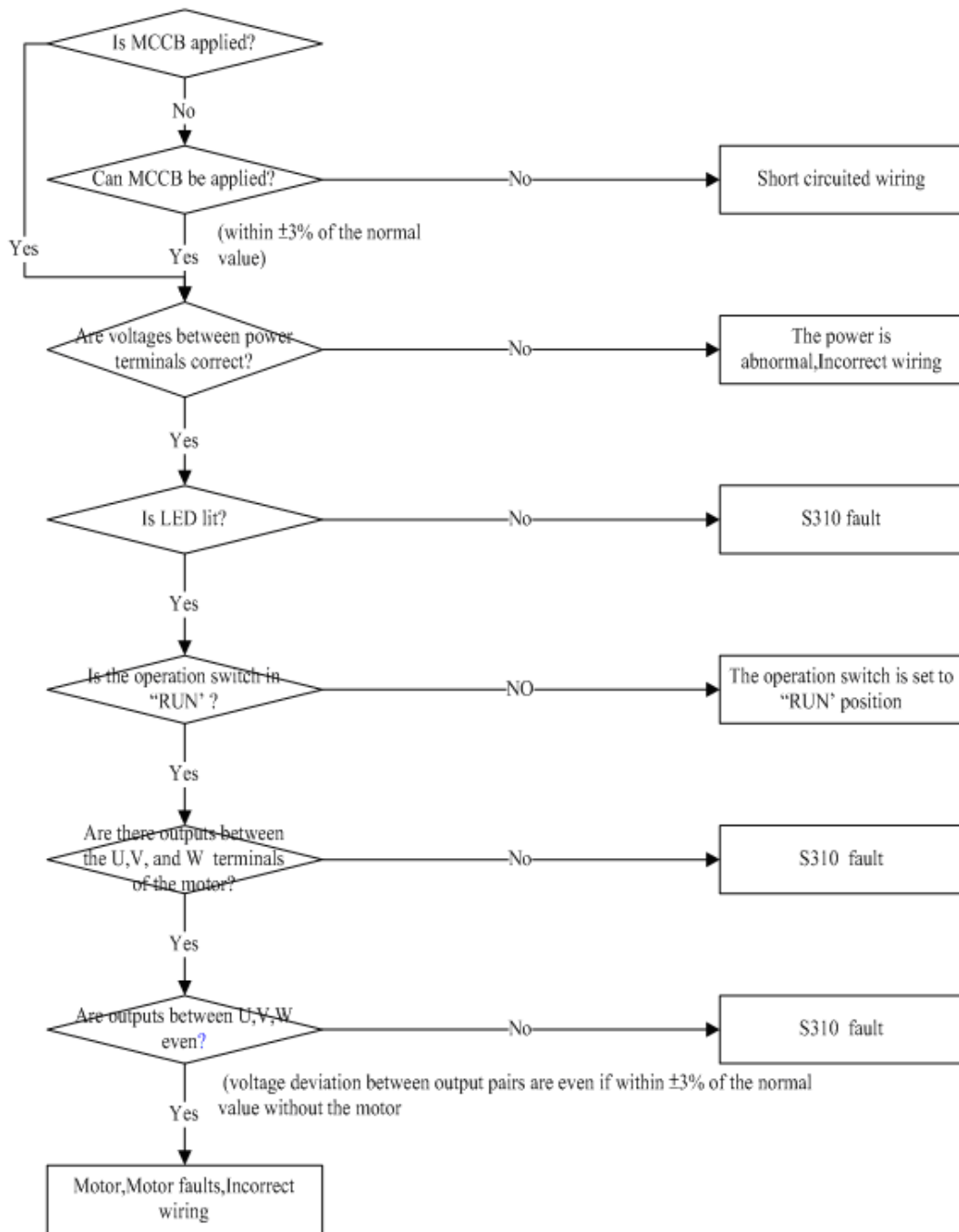

Figure 5-4 Motor RUN failure Flow chart

Motor Overheating

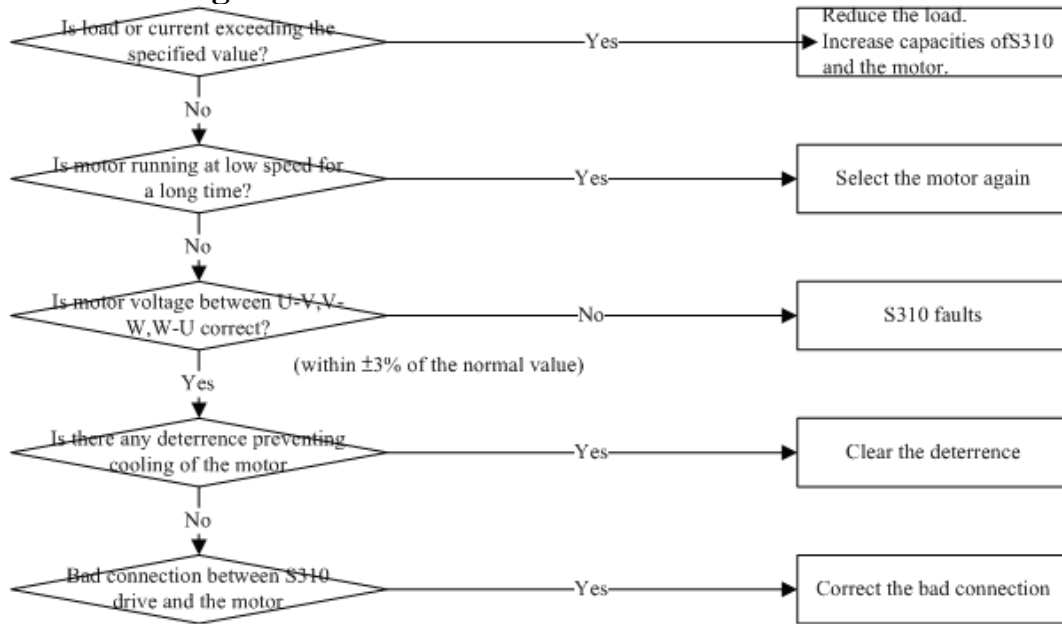

Figure 5-5 Motor Overheat Troubleshooting Flow Chart

Motor runs unevenly

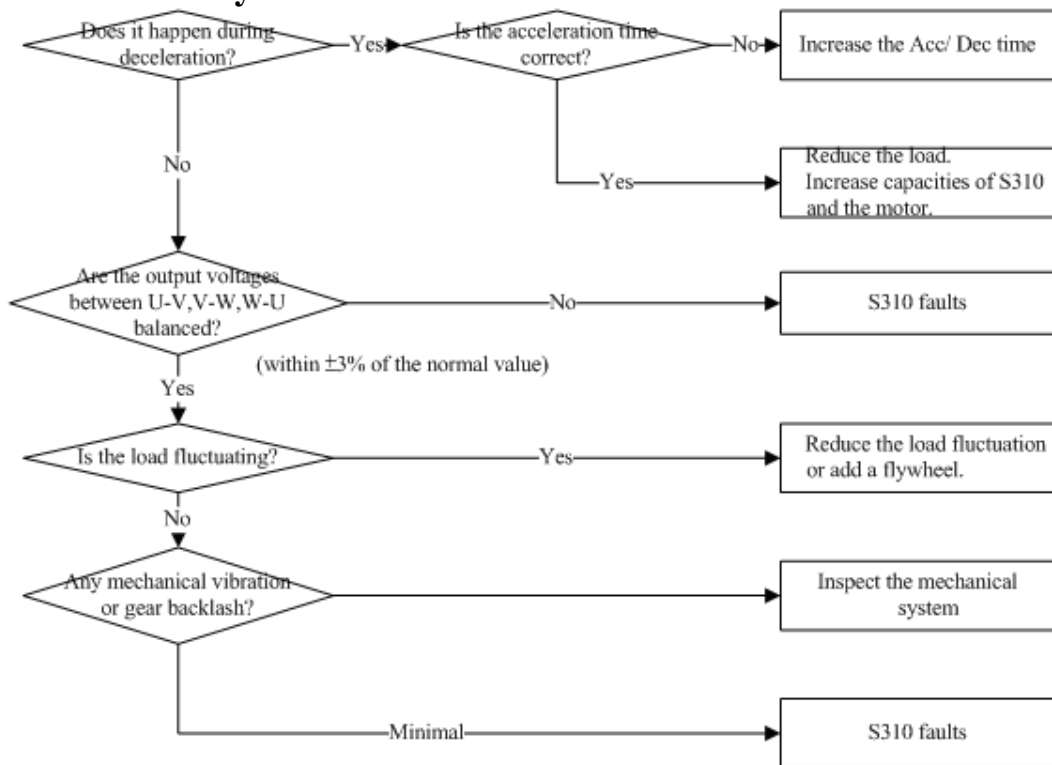

Figure 5-6 Motor Instability Troubleshooting Flow Chart

5.4 Routine and periodic inspection

To ensure stable and safe operations, check and maintain the inverter at regular intervals.

The table below lists the items to be checked to ensure stable and safe operations.

Check these items 5 minutes after the “Charge” indicator goes out to prevent injury to personnel by residual electric power.

Items	Details	Checking period		Methods	Criteria	Remedies
		Daily	1Year			
Ambient conditions around the machine	Confirm the temperature and humidity at the machine	<input type="radio"/>		Measure with thermometer and hygrometer according to installation notices.	Temperature: -10 – 40°C (14-120°F) Humidity: Below 95% RH	Improve the ambient or relocate the drive to a better area.
	Are there inflammable materials in the vicinity?	<input type="radio"/>		Visual check	Keep area clear	
Installation and grounding of the inverter	Any unusual vibration from the machine	<input type="radio"/>		Visual, hearing check	No vibration	Secure screws
	Is the grounding resistance correct?		<input type="radio"/>	Measure the resistance with a multi-tester	200Vclass: below 100 Ω	Improve the grounding
Input power voltage	Is the voltage of the main circuit correct?	<input type="radio"/>		Measure the voltage with a multi-tester	Voltage must conform with the specifications	Improve input voltage
External terminals and internal mounting screws of the inverter	Are secure parts loose?		<input type="radio"/>	Visual check Check with a screwdriver	Secure terminals and no rust	Secure or send back for repair
	Is the terminal base damaged?		<input type="radio"/>			
	Visual rust stains present?		<input type="radio"/>			
Internal wiring of the inverter	Any unusual bends or breaks?		<input type="radio"/>	Visual check	No abnormalities	Replace or send back for repair
	Any damage of the wire insulation?		<input type="radio"/>			
Heat sink	Excessive dust or debris	<input type="radio"/>		Visual check	No abnormalities	Clean up debris or dust
Printed circuit board	Excessive conductive metal shavings or oil sludge		<input type="radio"/>	Visual check	No abnormalities	Clean or replace the circuit board
	Discolored, overheated, or burned parts		<input type="radio"/>			
Cooling fan	Unusual vibration and noise		<input type="radio"/>	Visual or hearing check	No abnormalities	Replace the cooling fan
	Excessive dust or debris	<input type="radio"/>		Visual check		Clean fan
Power component	Excessive dust or debris		<input type="radio"/>	Visual check	No abnormalities	Clean component
	Check resistance between each terminals		<input type="radio"/>	Measure with a multi-tester	No short circuit or broken circuit in three-phase output	Replace power component or inverter
Capacitor	Any unusual odor or leakage	<input type="radio"/>		Visual check	No abnormalities	Replace capacitor or inverter
	Any deformity or protrusion	<input type="radio"/>				

5.5 Maintenance and Inspection

Inverter doesn't need daily inspection and maintenance.

To ensure long-term reliability, follow the instructions below to perform regular inspection. Turn the power off and wait for the charge indicator (LED) to go out before inspection to avoid potential shock hazard from the charge stored in high-capacity capacitors.

- (1) Clean up the accumulation of any dust inside the inverter.
- (2) Check if there are any loose terminal screws and tighten them.
- (3) Insulation tests
 - (a) Disconnect all leads connecting the INVERTER with external circuits when performing insulation tests on external circuits.
 - (b) Internal insulation test should be performed against the main circuit of the INVERTER body only. Use a high resistance DC 500V meter with insulating resistance higher than $5M\Omega$.

Caution! Do not perform this test against the control circuit.S310

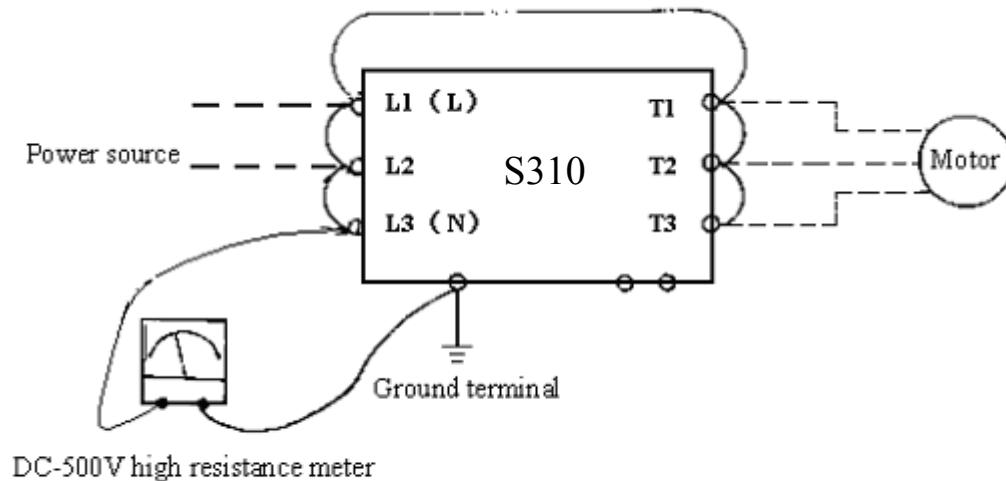

Insulation Test Diagram

Chapter 6 Peripherals Components

6.1 AC reactor and DC reactor specification at input side

Model	AC inductance at input side		Suitable Motor Capacity (HP)	Suitable Motor Capacity (KW)	Braking resistor Specification			Braking resistor Duty Cycle (%)	Braking torque (%)
	Current (A)	Inductance (mH)			(W)	(Ω)	Number used		
S310-2P5-H1xxx	5.2	4.2	0.5	0.375	60	200	-	8	218
S310-201-H1xxx	9.4	2.1	1	0.75	60	200	-	8	119
S310-202-H1xxx	19	1.1	2	1.5	150	100	-	10	119

Note 1: Formula for brake resistor: $W = (V_{pnb} * V_{pnb}) * ED\% / R$

1. W: braking resistor consumption power
2. ED%: braking effective period

6.2 Digital operator and extension cable

A. Content

1. ① Inverter
2. ② LED Keypad (S31DOP-01)
3. ③ Remote Cable for Keypad

Note: ③ Using standard network cable connection.

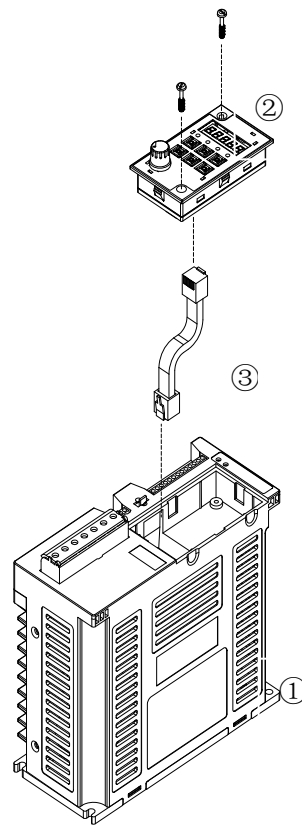

B. Operation procedure: Figure 6-1 Digital Operator Extension Cable

1. Turn off the power Supply; the following procedures should be performed after there is no display on the keypad.
2. Remove the keypad.
3. Connect the inverter and the keypad with REMOTE cable.

C. Keypad Installation Dimension Unit : mm

1. Keypad Installation Dimension

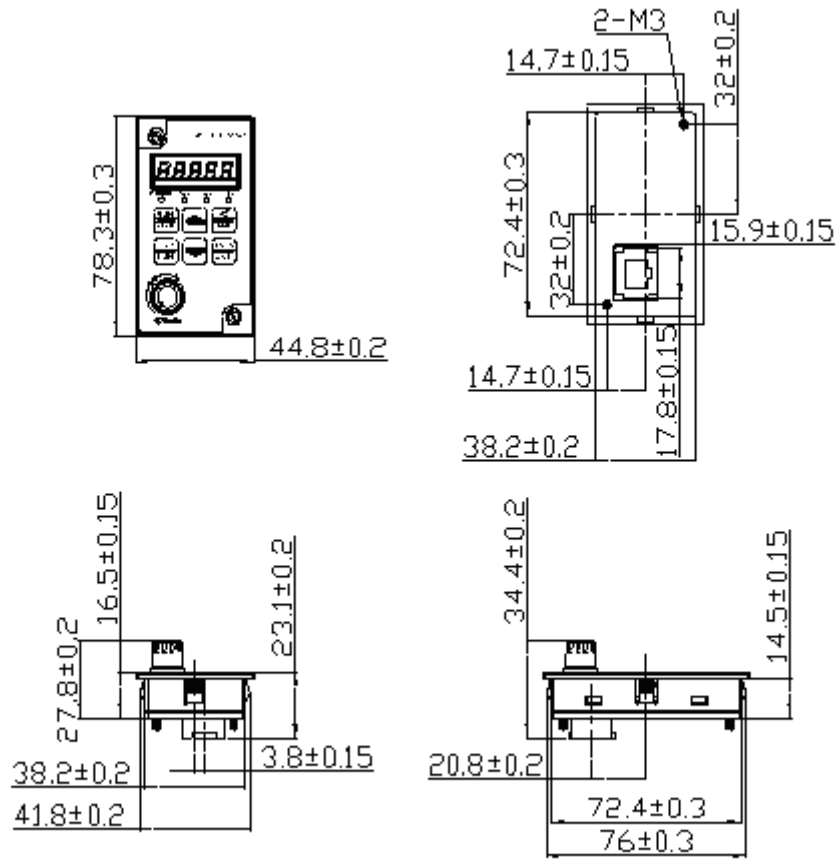

2. Dimension for remote keypad

a. Keypad hatch Installation Dimension

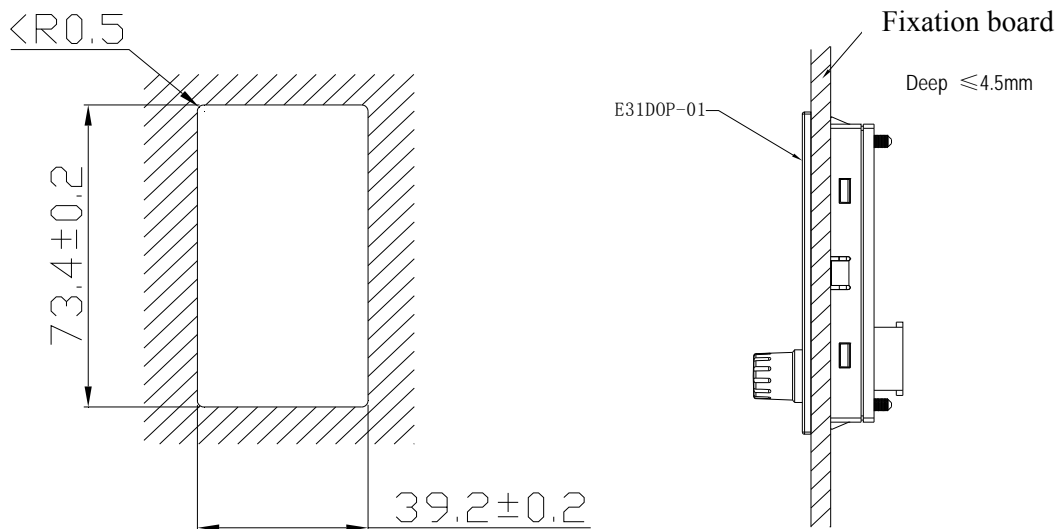

b. Keypad Installation Dimension for nut (superaddition gasket and nut)

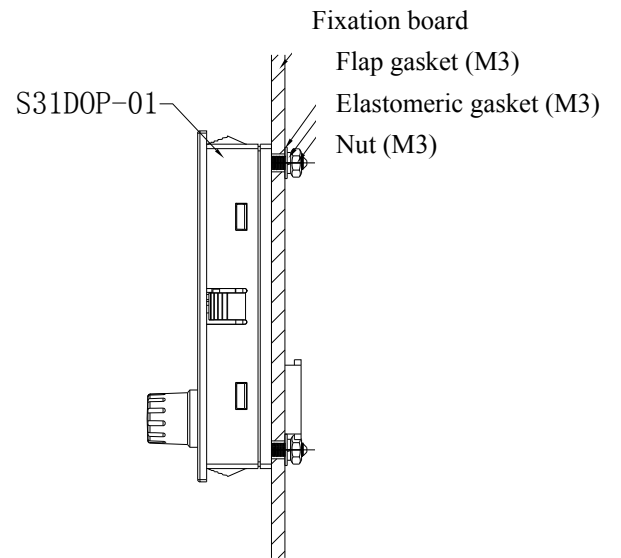
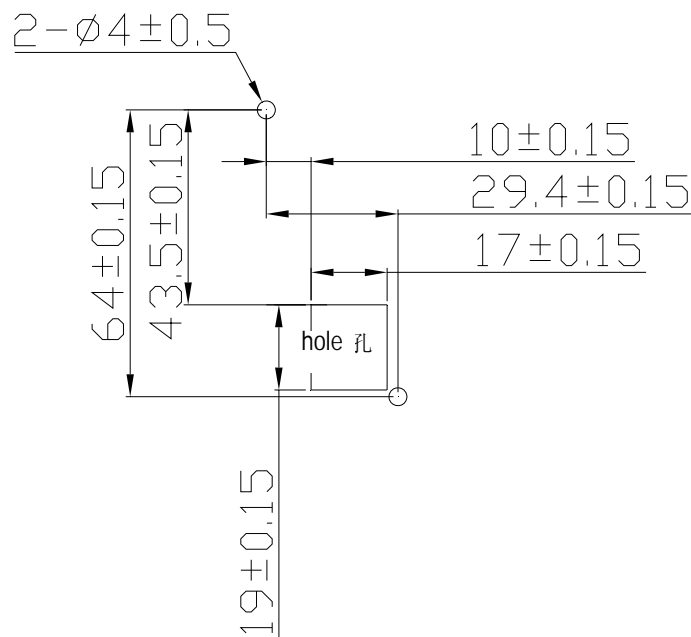

c. none gasket and nut, Keypad Installation Dimension

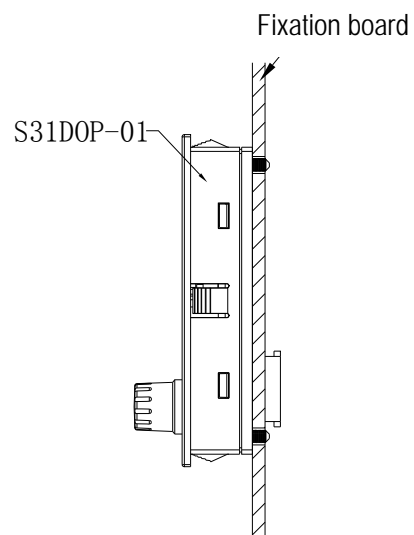
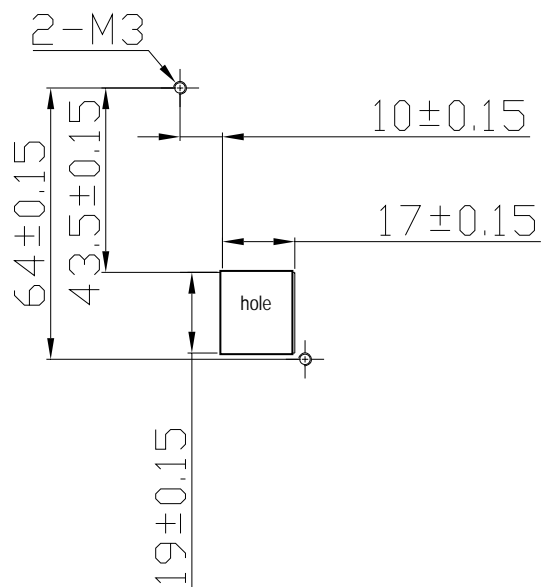

Appendix 1: S310 parameter setting list

Customer				Inverter Model			
Site Location				Contact Phone			
Address							
Parameter code	Setting content	Parameter code	Setting content	Parameter code	Setting content	Parameter code	Setting content
00-01		03-03		05-02		11-03	
00-02		03-04		05-03		12-00	
00-03		03-05		05-04		12-01	
00-05		03-06		05-05		12-02	
00-07		03-07		05-06		12-06	
00-08		03-08		05-07		12-07	
00-09		03-17		05-08		13-00	
00-10		03-18		05-09		13-01	
00-11		03-19		05-10		13-02	
00-12		03-20		05-11		13-03	
00-13		03-21		07-00		13-04	
00-14		03-22		07-01		13-05	
01-00		03-23		07-02		13-06	
01-01		03-24		07-03		13-07	
01-02		03-25		07-04		13-16	
01-03		03-26		07-05		13-17	
01-04		03-27		07-06		13-18	
01-05		03-28		07-13		13-19	
01-06		03-29		08-00		13-20	
01-09		03-30		08-02		13-21	
01-11		03-31		08-03		13-22	
01-12		03-32		08-04		13-23	
01-13		04-01		08-05		13-32	
02-00		04-03		08-06		13-33	
02-01		04-08		08-07		13-34	
02-02		04-09		08-08		13-35	
02-03		04-15		10-01		13-36	
02-04		04-16		10-03		13-37	
02-05		04-17		10-04		13-38	
02-12		04-18		10-16		13-39	
02-13		05-00		11-00			
03-00				11-01			
03-01				11-02			
03-02							



TECO Electric & Machinery Co., Ltd.

10F.,No.3-1 , Yuancyu St., Nangang District
Taipei City 115, Taiwan

Tel : +886-2-6615-9111 Ext : 1721

Fax : +886-2-6615-0933

[Http://www.teco.com.tw](http://www.teco.com.tw)

Distributor

VER: 02 2010.02

This manual may be modified when necessary because of improvement of the product, modification, or changes in specification, this manual is subject to change without notice.